

Guideline

# Technical Cleanliness in Electrical Engineering

Dirt is simply matter in the wrong place

2nd extended edition





## Technical Cleanliness in Electrical Engineering

Published by:

ZVEI - Zentralverband Elektrotechnik-  
und Elektronikindustrie e.V.

ZVEI - German Electrical and Electronic  
Manufacturers' Association

PCB and Electronic Systems Division

Electronic Components and Systems Division

Lyoner Strasse 9

60528 Frankfurt am Main, Germany

Phone: +49 69 6302-437

Fax: +49 69 6302-317

E-mail: [pcb-es@zvei.org](mailto:pcb-es@zvei.org)

[www.zvei.org](http://www.zvei.org)

Responsible:

Peter Trunz

PCB and Electronic Systems Division

In collaboration with:

Peter Fischer, BaTiLoy GmbH

Jennifer Kordel, BaTiLoy GmbH

Thomas Zeike, Continental AG

Ralf Kuballa, Hella GmbH & Co. KG a.A.

Dr. Petrik Lange, Hella GmbH & Co. KG a.A.

Dr. Oliver Fastje, Kolb Cleaning Technology GmbH

Christian Smits, Kolb Cleaning Technology GmbH

Christian Daum, Kostal Kontakt Systeme GmbH

Frank Petri, Kostal Kontakt Systeme GmbH

Dr. Marc Nikolussi, Robert Bosch GmbH

Jürgen Frey, TDK Electronics AG

Volker Seipel, TE Connectivity Germany GmbH

Andreas Zitz, TE Connectivity Germany GmbH

Harald Hundt, Vacuumschmelze GmbH & Co.KG

Dr. Helmut Schweigart, Zestron

Christian Sonnleitner, Zollner Elektronik AG

Michael Zimmerer, Zollner Elektronik AG

April 2019, 2nd extended edition



This work is licensed under the Creative Commons  
Attribution-Non-Commercial-Share Alike 4.0 Germany.

Despite utmost care for the content no  
liability will be accepted.





# Contents

<b>Foreword</b>	6
<b>1 Introduction</b>	7
<b>2 Technical Cleanliness</b>	8
2.1 What is technical cleanliness?	8
2.2 History – standardisation of technical cleanliness	8
2.3 Technical cleanliness in the electronics industry	9
2.4 Scope of this guideline	9
<b>3 Technical Cleanliness as a Challenge for Suppliers</b>	10
<b>3.1 Contamination</b>	10
3.1.1 Definition of particles	10
3.1.2 Definition of fibres	11
<b>3.2 Inspection procedure to determine technical cleanliness</b>	12
3.2.1 Fundamentals	12
3.2.2 Clarification form	13
3.2.3 System technology	13
3.2.3 Process parameters for pressure rinsing extraction	14
3.2.4 Process parameters for pressure rinsing extraction	14
3.2.5 Pressure rinsing process	15
3.2.6 Preparing membrane filters for technical measurement analysis	15
<b>3.3 Measurement analysis</b>	16
<b>3.4 Evaluating the results of cleanliness analyses</b>	17
3.4.1 “Introduction”	17
3.4.2 Particle count relative to component surface	17
3.4.3 Procedure for violation of action control limits	19
<b>3.5 Extended risk assessment</b>	19
3.5.1 Example	20
<b>3.6 Component cleanliness: Data management and visualisation</b>	21
<b>4 State of the Art: Technical Cleanliness in the Electronics Industry</b>	28
<b>4.1 Process flow (per cluster)</b>	28
4.1.1 Electronics manufacturing cluster	28
4.1.2 Passive components cluster	29
4.1.3 Electromechanical components cluster	30
4.1.4 PCB cluster	31
<b>4.2 Technical cleanliness in the electronics industry – actual situation</b>	31
4.2.1 Electronics manufacturing	32
4.2.2 Electronic components	32
4.2.3 Electromechanical components	36
4.2.4 Metal housing	40
4.2.5 Packaging	40
4.2.6 Printed circuit boards (PCBs)	41
<b>4.3 Determining potential particle sources in production</b>	43
4.3.1 Particle generation	43
4.3.2 Electronics manufacturing cluster	43
4.3.3 Passive components cluster	44
4.3.4 Electromechanical components cluster	47
4.3.5 PCB cluster	49

<b>4.4</b>	<b>Cleanliness-controlled design and process selection</b>	53
<b>4.5</b>	<b>Environmental cleanliness and visualisation</b>	56
<b>4.6</b>	<b>Cleaning tips</b>	60
4.6.1	Washing	60
4.6.2	Brushing	61
4.6.3	Suction-cleaning	61
4.6.4	Blowing	61
4.6.5	Reducing carry-over and controlling cleanliness in workplace design	62
4.6.6	Adhesive methods	62
<b>4.7</b>	<b>Packaging and logistics requirements</b>	63
<b>5</b>	<b>Why do metallic particles in assemblies so rarely cause short circuits?</b>	64
<b>5.1</b>	<b>Probability of contact</b>	65
5.1.1	Introduction and theory	65
5.1.2	Testing the probability of contact	67
5.1.3	Results	69
<b>5.2</b>	<b>Rinsing extraction versus actual mobility</b>	70
<b>5.3</b>	<b>Particle sinks</b>	70
<b>5.4</b>	<b>Effect of short circuits on ICs</b>	71
<b>5.5</b>	<b>Tool for estimating the risk of short circuit</b>	71
5.5.1	Introduction	71
5.5.2	Model hypotheses	72
5.5.3	Calculation methods	73
5.5.4	Orientation factor	73
5.5.5	Critical area	74
5.5.6	Number of particles per size class	75
5.5.7	Weighting factors	75
<b>5.6</b>	<b>Example use of the risk assessment tool</b>	77
5.6.1	Example use of the risk assessment tool for calculating failure rate	77
5.6.2	Example use of the risk assessment tool for design changes	78
5.6.3	Example use of the risk assessment tool for specification violations	79
<b>6</b>	<b>Summary</b>	80
<b>7</b>	<b>Outlook</b>	81
<b>8</b>	<b>Related Topics</b>	83
<b>8.1</b>	<b>Ionic contamination</b>	83
8.1.1	Filmic contamination	85
8.1.2	Biological films	85
8.1.3	Chemical films	85
<b>8.2</b>	<b>Whiskers</b>	85
<b>9</b>	<b>Further Reading</b>	87
<b>10</b>	<b>Participating Companies</b>	88
<b>11</b>	<b>Appendix</b>	90

# Foreword

Component cleanliness refers to the absence of particles on components which might otherwise impair downstream production processes and/or adversely affect the performance of a component or assembly.

A great number of different company standards have been created and developed based on national and international component cleanliness standards. This has led to an accumulation of varying requirements along the value chain, generating specifications that cannot be fulfilled.

The approaches and methods detailed in VDA 19 Part 1 and Part 2 are so generic that they can be applied to the complete range of automotive parts. Consequently, component and product specialists should be consulted to solve specific questions concerning cleanliness inspections and production issues.

This is where these ZVEI guideline comes in. Cleanliness inspections according to VDA 19 Part 1 and the design and optimisation of cleanliness-controlled production areas according to VDA 19 Part 2 are examined and further defined specifically with regard to the production of electric, electronic and electro-mechanical components, circuit boards and electronic assemblies. The guideline aims to significantly improve the hitherto inadequate comparability of analysis results by adapting and specifying cleanliness inspection processes specifically for the manufacture of electronic components and parts. It also suggests a system for analysing the results statistically and presenting them in a comprehensible manner. Furthermore, it provides targeted information for users about manufacturing steps and potential contamination risks. In addition to covering measuring and optimisation issues related to a company's level of technical cleanliness, this guideline also provides a joint basis for customer-supplier discussions. General limiting values – based on performance – were intentionally not specified in this guideline since levels of particulate contamination in the parts analysed varied considerably.

## Foreword to the second extended and revised edition:

The first edition of the guideline on component cleanliness was published in 2013. Our understanding of technical cleanliness has significantly increased in the meantime. In addition, VDA 19 has also been updated. These developments have now been addressed in the second edition of the guideline on component cleanliness and on our online platform at <https://bauteilsauberkeit.zvei.org>. As well as several changes which ensure continuing compliance with VDA 19, some chapters have been extended. For example, the empirical values for components have been updated and expanded and a 'clarification form' for the cleanliness analysis has been proposed (see: <https://bauteilsauberkeit.zvei.org>).

New content has also been added. For instance, the guideline now includes a calculation tool (see: <https://bauteilsauberkeit.zvei.org>) based on a scientific approach to assessing the risk of an electrical short circuit caused by conductive particles. Furthermore, it covers topics such as environmental cleanliness, data management, and cleanliness-controlled design as well as examining other related topics such as whiskers, film residues, ionic and biological contamination

We would like to thank all companies actively involved in the development of this guideline. Although this guideline is not binding, it has already proved of benefit to practitioners during the past five years.

# 1 Introduction

What is a clean component? How can I assess a component's cleanliness level? When is a component considered heavily contaminated? These questions have long been an issue in the manufacture of mechanical parts and must now be addressed by the electronics industry too as components become smaller and component density correspondingly greater. Metallic particles, for example, may cause short circuits and non-metallic particles may impair the correct assembly of circuit boards.

To prevent these difficulties, suppliers and customers have in the past agreed on specifications such as: "All components supplied must be clean", without specifying the cleanliness level. Today, increasingly detailed specifications deal with this subject.

VDA 19 Part 1, for instance, describes the conditions for applying and documenting methods for determining the particulate contamination of components. It provides a basis for developing cleanliness inspections that are comparable in terms of design and execution e.g. between customer and supplier. VDA 19 Part 2 serves as an additional aid in identifying and evaluating particle sources along the production chain.

The question of when a component is considered sufficiently clean can only be answered in the context of the relevant application. This is the only basis for defining maximum particle size and particle materials, when the performance of an assembly to be manufactured may be impaired, and how to ensure an uninterrupted production process. The limiting values to be specified for particles ensure that no particles outside the designated ranges are found on any component at the end of the manufacturing chain. Hence, a decision has to be made as to whether

- particles produced can be tolerated
- process optimisations to avoid particle generation are necessary
- particles are directly scrapped at their source
- all unwanted particles are specifically removed at the end of the manufacturing line.

Irrespective of the selected approach, one difficulty remains: troublesome particles are produced inadvertently rather than deliberately. They are a (sometimes undesirable) by-product and can neither be controlled nor prevented by (standard) statistical process controls.

## 2 Technical Cleanliness

### 2.1 What is technical cleanliness?

The term 'technical cleanliness' was coined by the automotive industry to address particle-related system interruptions in the automotive industry. In contrast to 'optical cleanliness', which relates to the cosmetic or visual appearance, e.g. vehicle coating, technical cleanliness always refers to the performance of components, assemblies and systems.

Particulate contamination in the automotive industry is often not limited to a certain area but may migrate from a previously non-critical to a sensitive location and hence impair performance. For instance, a particle on the lens of a traffic sign detection camera may cause it to malfunction. Similarly, a conductive particle from the aluminum cover of an electronic control unit may cause a short circuit on the circuit board and undermine its performance. This is why the cleanliness requirements of the automotive industry often apply to complete systems, whereby the most particle-sensitive component (weakest link in the chain) determines the cleanliness level and admissible limiting values for the entire system and all components within it. With regard to components, technical cleanliness refers to the specification, observance and verification of limiting values, e.g. according to weight of residual contamination, particle count, type and size. At the same time, the automotive industry tolerates failures only in the ppm range. New stipulations are continuously being added to the existing specifications. These are often tailored to suit the specific requirements of a company or component and its performance. Their scope of application is limited, i.e. they are valid in-house and/or for suppliers.

Although the term 'technical cleanliness' was coined by the automotive industry, the procedures relating to cleanliness inspections according to VDA 19 (liquid extraction, membrane filtration and subsequent analysis of

the retained particles) have been increasingly adopted by other industries such as medical technology, the optical industry, hydraulic and mechanical engineering. Since there is no such thing as total cleanliness or purity, the focus should be on the most practically feasible and economically viable solution for the designated location and purpose.

### 2.2 History – standardisation of technical cleanliness

Contamination had been a growing problem for the automotive industry since the early 1990s as systems became increasingly complex and installation spaces ever smaller. The anti-lock braking systems in general or direct fuel injection systems for diesel engines were particularly prone.

In some cases, customers and suppliers concluded individual agreements about technical cleanliness to address the risk of potential damage.

As a result, the automotive industry called for the introduction of general standards regulating the technical cleanliness of components. In summer 2001, TecSa was founded, an industrial alliance for technical cleanliness. This panel published VDA 19 "Inspection of Technical Cleanliness – Particulate Contamination of Functionally-Relevant Automotive Components" in 2004, which was revised in 2015 and republished as VDA 19 Part 1. This guideline makes recommendations for inspecting the technical cleanliness of automotive products.

Its international counterpart is standard ISO 16232, which was published in 2007.

In 2010, VDA 19 Part 2 "Technical Cleanliness in Assembly" was published, detailing cleanliness-related design aspects for assembly areas.



## 2.3 Technical cleanliness in the electronics industry

The industry increasingly uses the generally valid VDA 19 guideline in addition to company-specific standards.

This guideline proposes a system for designing and implementing component cleanliness analyses to enable quantifiable comparisons of component cleanliness levels. However, VDA 19 does not specify any limiting values for component cleanliness. These must be defined according to component function, producibility and verifiability.

The aim of the ZVEI working group on component cleanliness was to produce a guideline that supplements VDA 19 and ISO 16232 by addressing outstanding questions and providing practical solutions.

The producibility of a component as well as its performance must be considered in this context, as is the case when defining dimensional tolerances. Production processes, production environment and final packaging also influence component cleanliness. This often calls for agreements concerning compliance with limiting values between customer and supplier or product development and production. This is particularly relevant in instances where limiting values are exceeded without necessarily impairing performance. A careful review must be carried out to ensure that efforts to comply with these values do not outweigh the potential risk, thereby avoiding excessive cleanliness requirements.

### Potential particle-related malfunctions

Limiting values for component cleanliness ensure component performance and should be defined as early as possible during the component development stage. The following possible malfunctions should be considered:

- electrical short circuit
- shorter creepage and clearance distance
- electrical insulation of contacts
- impairment of optical systems such as cameras

- reduced wettability/solderability
- mechanical obstruction
- increased or reduced friction
- increased or reduced power
- leaks
- ...

If the remaining particulate contamination – also called residual contamination – is sufficiently low in a technical system to cause no short or long-term performance impairment or system damage, the system is considered adequately clean in the context of technical cleanliness.

## 2.4 Scope of this guideline

This guideline applies to the manufacture of electric, electronic and electromechanical components, circuit boards and electronic assemblies that are produced with state-of-the-art standard production methods and describes the resulting level of technical cleanliness that can be expected from the product and processes.

This guideline is a reference document which serves to illustrate the technically feasible options and provide a basis for customer and supplier agreements. It is not intended to be regarded as a specification or standard, nor does it cover the production of electric motors, batteries, cable harnesses and relays.

Its primary focus is on component cleanliness with regard to loose or easily detachable particles (labile particles). Film residues, ionic and biological contamination are also covered. It does not deal with the cleanliness of functional fluids and/or gases.

This guideline uses case studies to elaborate on VDA 19, provides information about particle generation subject to processes and materials, illustrates their impact on performance and reliability and describes suitable countermeasures.

# 3 Technical Cleanliness as a Challenge for Suppliers

In the past, drawings usually contained rather general information on component cleanliness, which was not systematically verified. Example:

**Parts must be free from contamination e.g. swarf, release agents, grease, oil, dust, silicone...**

With the publication of VDA 19/ISO 16232, standardised cross-company procedures were defined to record, analyse and document component cleanliness information.

General attributive provisions that had previously been customary and checked via visual inspection were replaced, e.g. by specifying particle size classes with maximum particle count, which can be verified by means of laboratory analysis.

The procedures to determine component cleanliness according to VDA 19 are standardised, reproducible and also more objective than previously applied methods. However, the following points should be observed when applying these procedures:

- Particle generation may vary significantly, even from the same production glass.
- Particle detection depends on the method and quality of analysis.
- Inspections are costly and require a laboratory.
- Measurement system analyses (MSA) are not possible for the entire inspection process of technical cleanliness.
- In-process inspections with associated regulatory measures can be implemented only after lengthy delays.

In practice, cleanliness analyses according to VDA 19 are used for production releases or requalification, during production and when there are reasonable grounds for suspicion.

Limiting non-metallic particle contamination (e.g. dust, lint, abrasion, etc.) poses a further challenge to the supplier. If these particles are classified as functionally critical and hence limited, account must also be taken of the manufacturing environment, suitability for subsequent cleaning, packaging (to maintain cleanliness) and logistical considerations when determining the limit. Detailed information is provided in VDA 19 Part 2. The controlled production conditions (clean zone grades) necessitated by this require more effort and expenditure. For this reason, it is advisable to determine limiting values only where functionally relevant.

## 3.1 Contamination

### 3.1.1 Definition of particles

VDA 19 Part 1 defines a particle as a solid body composed of metal, plastic, minerals, rubber or a salt. Paste-like fractions are not considered to be particles.

The following terms and definitions for metallic and non-metallic particles apply to the terminology used in this guideline.

#### 3.1.1.1 Metallic particles

Metallic particles are particles that are primarily characterised by a shiny metallic, reflective surface. They can be detected through a combination of normal and polarised light imaging. An optical microscope with the relevant features normally suffices for identifying metallic particles.

However, using optical microscopy for metallic particle detection bears the following potential risks:

- Extremely small metallic particles or sintered metals cannot be identified as metallic particles.
- Strongly oxidised metallic particles cannot be identified as metallic particles.
- Reflective non-metals, such as glass, may be wrongly classified as metallic particles due to their reflective behaviour.

Since it would be too costly and time-consuming to differentiate between electrically conductive and non-conductive particles when assessing the technical cleanliness of the production process, or indeed impossible, the analysis concentrates on detecting metallic and shiny metallic particles.

Shiny metallic particles are generally assumed to be both metallic and conductive.

It must be stressed that differentiating between metallic and non-metallic particles by their metallic lustre does not permit a reliable distinction to be made regarding their electrical conductivity.

The following steps can be taken to avoid these pitfalls: Manually re-examine the biggest metallic and biggest non-metallic particles detected using an optical microscope. Subsequently reclassify these particles if necessary.

Other systems such as EDX, Raman or laser-induced breakdown spectroscopy provide more detailed and conclusive results. However, this entails greater expenditure.

#### 3.1.1.2 Non-metallic particles

Non-metallic particles are particles that are not primarily characterised by a shiny metallic, reflective surface. They contain no fibres.

### 3.1.2 Definition of fibres

Component cleanliness analyses invariably detect textile fibres from clothing, which are ubiquitous in any production or laboratory environment where people are present. Fibres are non-metallic particles, which, although usually mentioned in the test reports, are not considered in the evaluation. To be classed as a fibre, they must meet the following specific geometric boundary conditions in accordance with VDA 19 Part 1:

- stretched length / maximum incircle  $> 20$  and
- width measured across maximum incircle  $\leq 50 \mu\text{m}$

In simple terms, this means that:

- the length-to-width ratio is 1:20 and
- the width of a fibre is  $\leq 50 \mu\text{m}$

Notes on the definition:

- Implementing this theoretical approach with customary two-dimensional optical test systems often lacks a certain amount of precision.
- Compared with previous definitions, a shift in the number of non-metallic particles and fibres must be envisaged with this approach.
- Based on the current definition, a human hair with a thickness of approx.  $60 - 80 \mu\text{m}$  would be classed as a non-metallic particle rather than a fibre.
- In contrast, a glass or carbon fibre with a thickness of  $40 \mu\text{m}$  would be classed as a fibre rather than a particle, although it clearly has the potential to cause damage.

The following potential errors may occur when identifying fibres:

- Fibres with a strong curl cannot be detected.
- Particles may be wrongly identified as fibres if the width and height are very small in relation to the length (e.g. plastic burr).
- Fibres positioned vertically to the membrane (in the z-axis) may be analysed incorrectly or not at all.
- Fibres may be visually "chopped" and not detected as one fibre.

### 3.2 Test procedure to determine technical cleanliness

#### 3.2.1 Fundamentals

The technical cleanliness of components refers to the level of particulate contamination on the relevant surfaces of test objects.

The aim of cleanliness inspections is to determine and measure the particle count as accurately as possible.

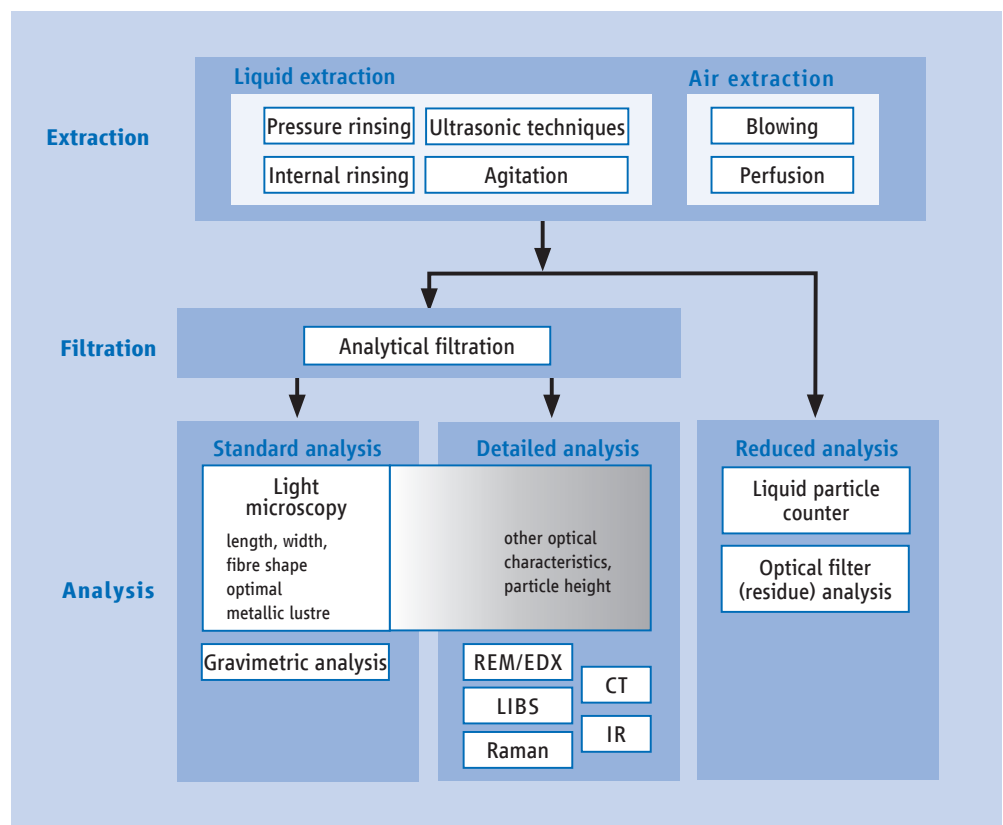
VDA 19 describes the application methods and conditions to determine and document particulate contamination. It also specifies the different extraction and analysis methods.

The following extraction methods are suggested for removing particles on electric, electronic and electromechanical components, circuit boards and electronic assemblies (hereafter referred to as 'components'):

- pressure rinsing
- ultrasonic techniques
- internal rinsing
- agitation
- air extraction

According to the ZVEI working group on component cleanliness, 'pressure rinsing' as defined in VDA 19 has proved to be a reliable extraction method for a number of applications. Components are rinsed with liquid pressure jets during this process. The liquid is then filtered to separate the released particles for further analysis.

Fig. 1: Test method as per VDA 19 Part 1



To properly evaluate the cleanliness level of the component, the pressure rinsing extraction process must be qualified. This is done by repeating the process several times and reevaluating the results each time. The count of extracted particles must continuously decrease. By the sixth analysis at the latest, the particle count must be  $\leq 10$  percent of the sum of all previous analyses (all relevant particles in total). This is referred to as an extraction curve. The extraction curve is a prerequisite for series analyses and must be determined once for each component type.

The cleanliness of an extraction system and hence its suitability is determined without components. The same parameters are used for this component-free pressure rinsing process as for an analysis with components. The particle count obtained provides the basis for the release of the system for the next test and is referred to as the blank value.

The extraction method described in Chapter 3.2.4 is based on VDA 19 and details the use of pressure rinsing to separate particles from components and collect them on a filter membrane for subsequent measurement and analysis.

Particles that cannot be separated from the components by extraction are classified as "tightly adhering" and are not considered in the context of component cleanliness.

### 3.2.2 Clarification form

The clarification form defines all the specific test parameters required for an analysis. It is required not only for performing an analysis, e.g. in an analytical laboratory, but also for the internal review of different analyses and for submission to the customer for approval based on the test parameters from the requirements specification.

How else can we ensure that comparable measurements have been analysed under the same conditions, e.g. with the same filter types and the same mesh width?

It is always advisable to design a clarification form that clearly defines those parameters which ensure comparability of analyses.

All options for performing an analysis must be specified (see Fig. 1).

This revised guideline now includes sample clarification form templates for 'environmental cleanliness' and 'component cleanliness' (see appendix). Not everyone who requires an analysis has the specialist knowledge required to complete a clarification form in full.

For this reason the clarification form is divided into two sections:

The first section covers the following points and must be completed by the requester:

- information about the test component
- sampling conditions
- cleanliness requirements
- etc.

The second section should be completed by the specialist:

- details of particle count
- type of filtration and filter
- presentation of results
- how packaging is dealt with
- etc.

The use of a clarification form greatly simplifies the internal management of analyses which are intended to be compared with another. Furthermore, it also simplifies the commissioning process by reducing follow-up inquiries from the analytical laboratory regarding unclear or missing parameters.

Fig. 2: Examples of extraction systems



### 3.2.3 System technology

The following criteria must be considered when designing a pressure rinsing system:

#### Component holder

Containers or funnels which discharge directly to the filter membrane. If necessary, a suitable sieve can be placed in the container to hold the component. If particles are simultaneously extracted from several components, the components must not be placed on top of each other but next to each other. It is important to avoid generating new particles during the extraction process.

#### Pressure rinsing equipment

An easily maneuverable pressure rinsing tool (lance) with a round nozzle of e.g. 4 mm diameter is suitable for pressure rinsing components manually at stable flow rates.

#### Membrane holder

Membrane filters must be easily removed from storage containers and loaded into the equipment, if necessary using tweezers. To ensure that no liquid remains between container and membrane filter, which would prevent the detection of particles, it is advisable to extract the test liquid from the container holding the components (if necessary by vacuum suction).

#### Number of components per test

The surface of the test components must be sufficiently large to provide statistical data on component cleanliness. It is advisable to select the number of components per test which ensures the smallest possible extrapolation factor based on a 1000 cm<sup>2</sup> reference surface area. However, no more than 50 components should be tested for practical reasons (see Chapter 3.4.2).



### 3.2.4 Process parameters for pressure rinsing extraction

1. Extraction method:	Pressure rinsing according to VDA 19
2. Test liquid <sup>1)</sup> :	Solvent cleaners based on non-aromatic aliphatic or alicyclic hydrocarbons with a terpene content of < 30 percent, e.g.: Haku 1025-921, De-SOLV-IT 1000, G60
3. Flow volume:	1000 ml/min ± 200 ml/min
4. Nozzle:	Lance with 4 mm round nozzle
5. Filter type (membrane):	5 µm pore size, approx. 47 mm membrane diameter Material e.g. cellulose nitrate, PET mesh
6. Pressure rinse volume:	Result of extraction curve (approx. value: 2–6 l)
7. Final rinse volume <sup>2)</sup> :	Approx. value ≥ 2000 ml
8. Number of components:	1 to 50 units or ideally ≥ 200 cm <sup>2</sup> surface area

### 3.2.5 Pressure rinsing process

Care must be taken to ensure that the spray reaches the target surface of all components during the pressure rinsing process. To achieve this, the pressure rinsing device (lance) is directed along the entire surface of all components at a distance of approx. 1 to 10 cm until the rinse volume has been reached. The test components must be handled in a manner which ensures that no further particles are generated during the extraction process (e.g. due to abrasion).

**Fig. 3: Component holder during manual pressure rinsing**



The components are then removed and the empty component holder with container is rinsed as part of the extraction process.

### 3.2.6 Preparing membrane filters for measurement analysis

On completion of the extraction process, the membrane filters must be dried at room temperature or using a drying oven. To prevent additional contamination or loss of particles on membranes, the oven should be operated without air recirculation. A desiccator may also be used for drying the membrane filters at room temperature (approx. 12-24 h) to protect them from contamination. Petri dishes can be used to facilitate the handling of moist membrane filters.

This process must take place in a clean environment which will not adversely effect the results.

<sup>1)</sup>The compatibility of solvent, components and assemblies should be verified at least once during testing.

<sup>2)</sup>The final rinse volume is **not** determined by the decay test, but by the extraction chamber used.

**Fig. 4, 5: Examples of different options for drying membrane filters**



The dried membranes can be mounted in standard slide frames (60 x 60 mm) for the measurement analysis.

**Fig. 6: Slide frame with membrane filter**



**Note:**

The qualification test (extraction curve) and blank value determination must be performed in line with VDA 19 Part 1.

For the first decay test to determine the extraction curve, 1 litre of pressure rinsing liquid per extraction process may be used for reference.

In the event that no decay takes place and the decay criterion is not reached, the process must be repeated with a higher volume of liquid and new components.

Once dried, the components used for analysis purposes may be re-fed to the production process.

**3.3 Measurement analysis**

Light microscopy is normally used to evaluate the particles on the membrane filters. The microscope and camera automatically scan the membrane filters and determine the shape and dimensions of the individual particles. Software then classifies the particles according to the size classes defined in VDA 19, differentiating between metallic and non-metallic particles according to Chapter 3.1.1. Fibres (see 3.1.2) are not usually considered in the evaluation.



Heavily contaminated membrane filters may result in analytical errors due to overlapping particles. In this case, the number of test components per analysis should be reduced to minimise the risk. Alternatively, cascade filters can be used.

In addition to extremely contaminated membrane filters, other parameters such as:

- filters (pore size, material, mesh structure)
- filter handling (positioning in measurement system, transport)
- microscopes
- image processing (software)
- analysis methods (cross-polarisation, EDX, Raman spectroscopy)
- illumination systems (incidental light, light/dark field, transmission light)

may skew the results of the particle count.

### 3.4 Evaluating the results of cleanliness analyses

#### 3.4.1 "Introduction"

Particles on components are not generated deliberately using defined methods, but arise as incidental waste products. For this reason, the particle generation process is neither stable nor actionable, and therefore particles have a wider spread compared with characteristics that have been specifically produced. Although component cleaning effectively reduces the number of particles, it does not significantly alter their spread.

VDA 19 Part 1 (Ch. 2.1) defines cleanliness limits as action control limits rather than tolerance limits. When a limit is exceeded, it does not necessarily mean that an error has occurred; it increases its likelihood of occurrence. An error occurs only when a critical particle is found at the right time in the right location on a sensitive position within the system.

The aim of the cleanliness analysis is not to find random errors arising from the large spread of cleanliness values, but to find systematic errors such as worn tools, errors in the cleaning process, incorrect storage conditions and incorrect process parameters.

Particle numbers and dimensions are difficult, if not impossible, to predict during the planning phase. They are influenced by numerous process and environmental parameters which are difficult to control. Measuring particles on existing components (samples if necessary) or using comparable components for reference (creating groups) is the most reliable method of obtaining information on particulate contamination for (future) series production.

Of the different procedures available to measure particles, the two variants below are the most common:

- a) Determining particle count per particle class
- b) Determining maximum particle length

The appropriate variant is selected on the basis of the parameters, specifications or requirements.

#### 3.4.2 Particle count relative to component surface

The option mentioned in VDA 19 Part 1 is most widely chosen in practice, in which the number of particles detected is expressed relative to a 1000 cm<sup>2</sup> component surface area. This is useful when comparing the contamination level of different sized components. If during the extraction process fewer components are rinsed than would be necessary to achieve 1000 cm<sup>2</sup>, the number of particles detected per class must be extrapolated to 1000 cm<sup>2</sup>.

When measuring technical cleanliness, it is important to aim for the largest possible component surface area (at least 200 cm<sup>2</sup>, ideally 1000 cm<sup>2</sup>). However, a tiny chip component, e.g. EIA0603, would have to be extrapolated by a factor of 300 or more to avoid having to use several thousand parts for a cleanliness analysis. Clearly it would not make economic sense to use such a large number of components.

This extrapolation process may result in a very high particle count for a specific particle class, when in reality only a single particle may have been found in this class on one occasion. In such cases it is not normally possible to comply with the permitted blank value (10% rule as per the VDA 19 Part 1) because small components carry too few particles. The smaller the total surface area of the components being analysed, the greater the disproportionate rise in the ratio of particles originating from the analytical equipment with no products.

A method is proposed below to reduce the influence of the blank value on the measurement results during the extrapolation process. After the measurement, the (theoretical) blank value is initially deducted, the measurement result is extrapolated to 1000 cm<sup>2</sup> and then the blank value is added to the extrapolated result. In this case, the blank value is estimated to be x percent of the total contamination.

This procedure is expressed in the following extrapolation formula:

$$N = n \times (1000+B) / (A+B)$$

*N = number of particles extrapolated to 1000 cm<sup>2</sup> component surface*

*n = number of particles on all components measured*

*A = surface area of components measured in cm<sup>2</sup>*

*B = blank value equivalent in cm<sup>2</sup> corresponds to x % of 1000 cm<sup>2</sup>*

**Table 1: Influence of the blank value on the measurement results for different material surfaces (examples for a blank value fraction of 2.2% and above)**

Surface of components measured in cm <sup>2</sup>	1000	500	200	29	10	1
Blank value equivalent in cm <sup>2</sup> (corresponds to 2.2% of 1000 cm <sup>2</sup> )	22	22	22	22	22	22
Blank value fraction in %	2.2%	4.2%	10%	43.1%	68.8%	95.7%
Pie chart showing blank value fraction (light blue)						
<p><b>Example (see blue column in the table):</b>            One Class H metallic particle (200–400µm) was found during a cleanliness inspection of 50 components with a total surface area of 29 cm<sup>2</sup>.            A 'normal' extrapolation to 100 cm<sup>2</sup> (multiply 1000/29) gives a value of 35 Class I particles on 1000 cm<sup>2</sup>.            Extrapolation using the abovementioned formula gives a value of 20 metallic particles on 1000 cm<sup>2</sup>.</p>						

### 3.4.3 Procedure for violation of action control limits

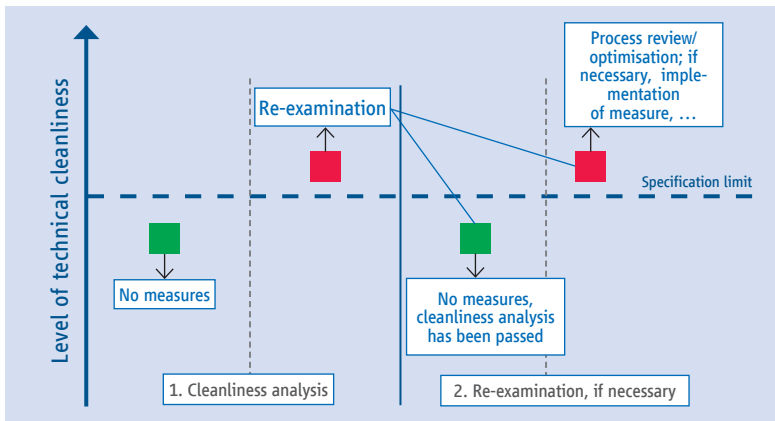
Due to the large spread of particle occurrence, a single analysis has only limited meaningful value. In order to distinguish between systematic and random discrepancies, several cleanliness analyses must be performed.

The following course of action is recommended:

If a particle count is exceeded in one class, a further analysis must be performed.

If only part of a component surface was analysed due its very large size, when the test is repeated at least three parts per analysis must be tested to increase the reliability of the information obtained from the new analyses.

**Fig. 7: Example procedure if specifications are exceeded**



If the cleanliness values obtained from these additional analyses lie within the agreed limits, it is fair to assume that the discrepancy was a random event and the entire cleanliness test is deemed to have been passed successfully.

However, if one value from these additional analyses again lies outside the agreed values, it may be a systematic discrepancy. Different follow-up measures can then be taken:

- Review and optimise the manufacturing process and perform further follow-up tests. It is useful at this point to perform materials tests on the particles found to help pinpoint their source
- Re-clean
- Exceptional release in individual cases following an appropriate risk assessment
- Increase the confidence interval by testing further components from the same production batch
- ...

### 3.5 Extended risk assessment

The cleanliness risk can be estimated more accurately by applying the following approaches; the likelihood of occurrence of particles above a certain size can be inferred from the data obtained from a single cleanliness analysis.

1. Use one or several analyses to determine raw data by particle measurements according to VDA 19 Part 1 or the chapter in this guideline entitled "Definition of a suitable test procedure incl. parameters". The greater the number of analyses, the more accurate the estimation. The data should contain the true sizes of the relevant particles. The number of relevant particles should be sufficient to enable statistical evaluation.
2. Experience shows that particle size and count create a function similar to exponential distribution. The data must be transformed into a natural distribution using a suitable program to allow statistical evaluation.
3. It is also possible to obtain information on the likelihood of occurrence of particles above a certain size even if these were not found in the analysis by taking into account the test samples used for the analysis.

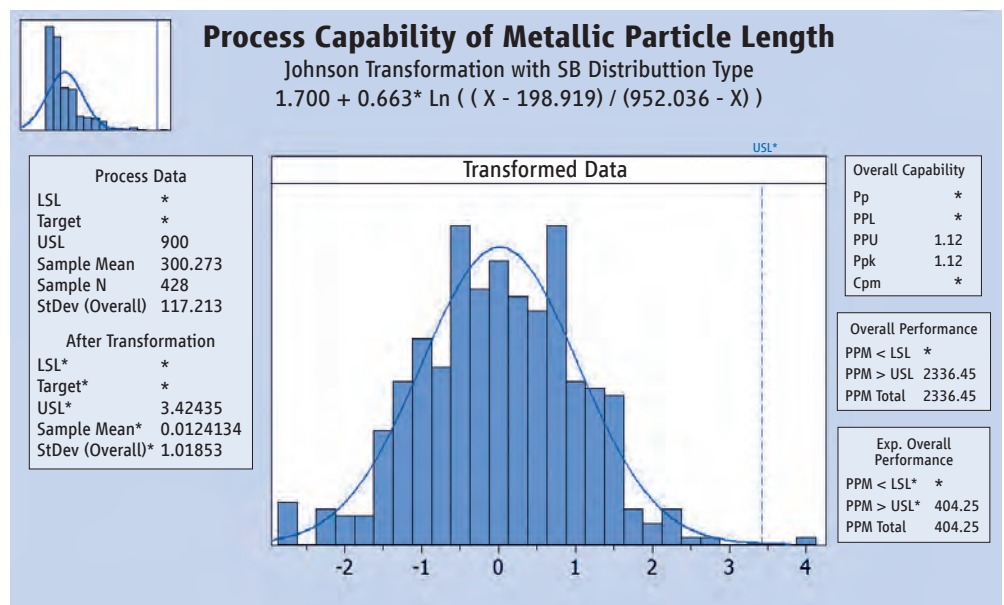
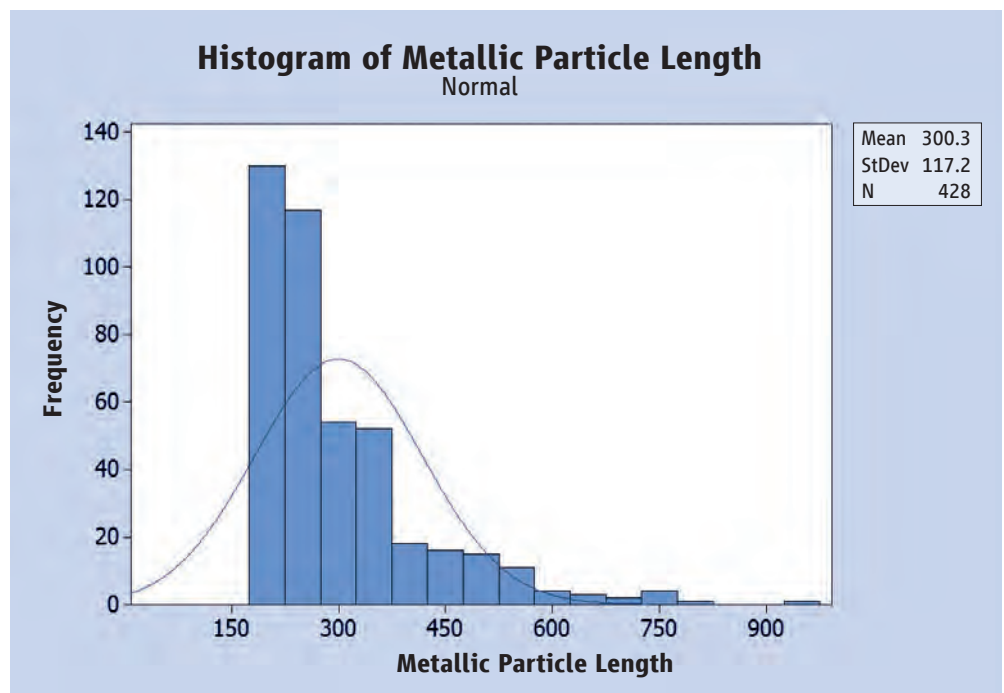
### 3.5.1 Example

A total of 428 particles ( $\geq 200 \mu\text{m}$ ) has been extracted from 1510 contacts and analysed in terms of size in this example.

- When extrapolated, this corresponds to 283,443 particles ( $\geq 200 \mu\text{m}$ ) on one million contacts.
- Statistically, 404.25 ppm or 114 particles of these are  $\geq 900 \mu\text{m}$ .

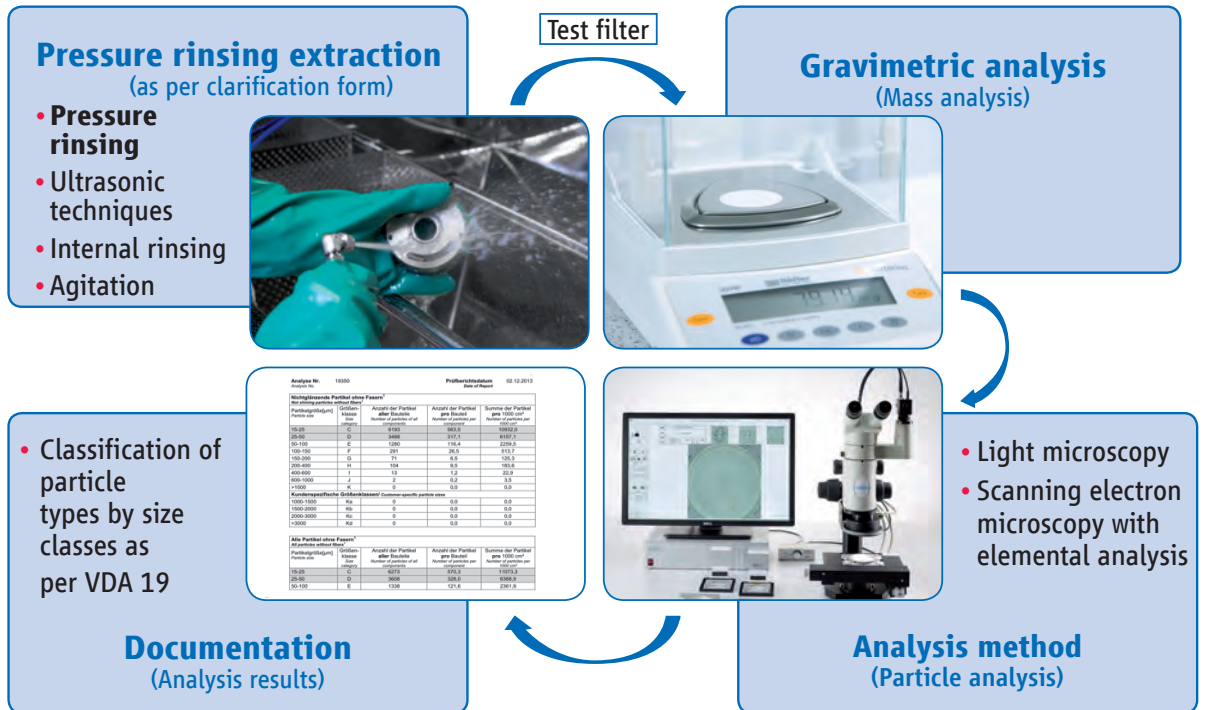
Assuming an even particle distribution, i.e. max. 1 particle per contact, one metallic particle  $\geq 900 \mu\text{m}$  can be found on 114 out of 1 million contacts, which corresponds to a failure rate of 114 ppm.

Fig. 8: Particle size distribution



### 3.6 Component cleanliness: Data management and visualisation

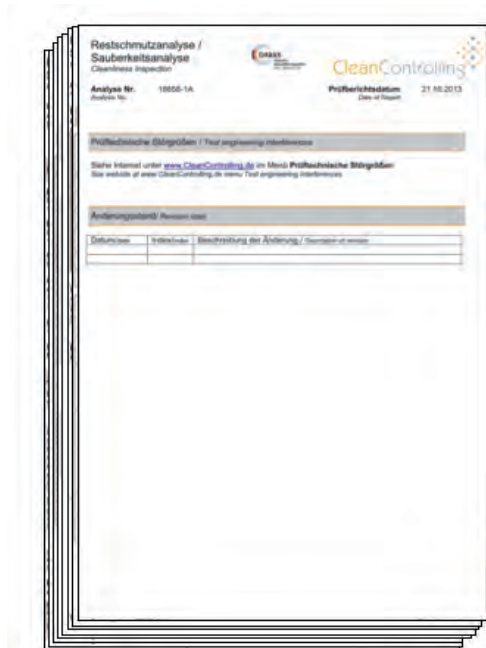
Fig. 9: Flow diagram for component cleanliness analysis



All test and analysis parameters must be defined before conducting component cleanliness analyses. The clarification form or a company specification sets out the conditions

under which the laboratory is to perform the analysis in question (regulation of analytical values/parameters).

Fig. 10: Scope of analytical report



Clearly defined performance standards, i.e. the same framework conditions, are the only way to ensure comparability with other analyses (see Chapter 3.2.2).

The analytical laboratory must provide the following information:

- analysis report in compliance with e.g. VDA 19 Part 1 incl. indication of blank value
- test specification incl. decay test

Optional:

- video showing the performance of the decay measurement
- filter

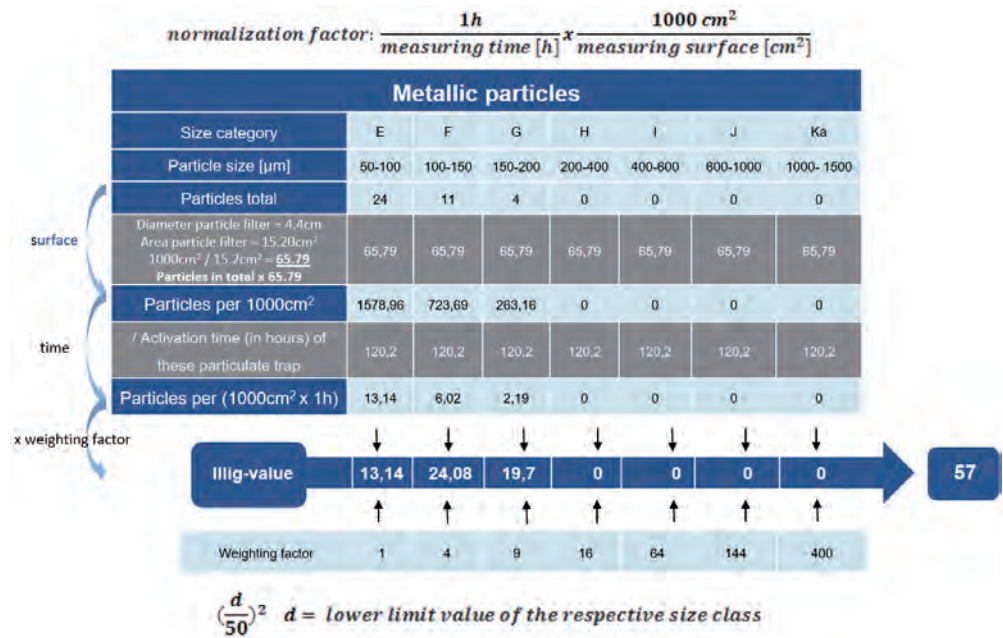
**Explanation of SCI  
(Surface Cleanliness Index):**

The Illig value can be used to compare the environmental cleanliness of production areas and assess measures that have been introduced: For example, does a new ventilation system achieve the desired effect?

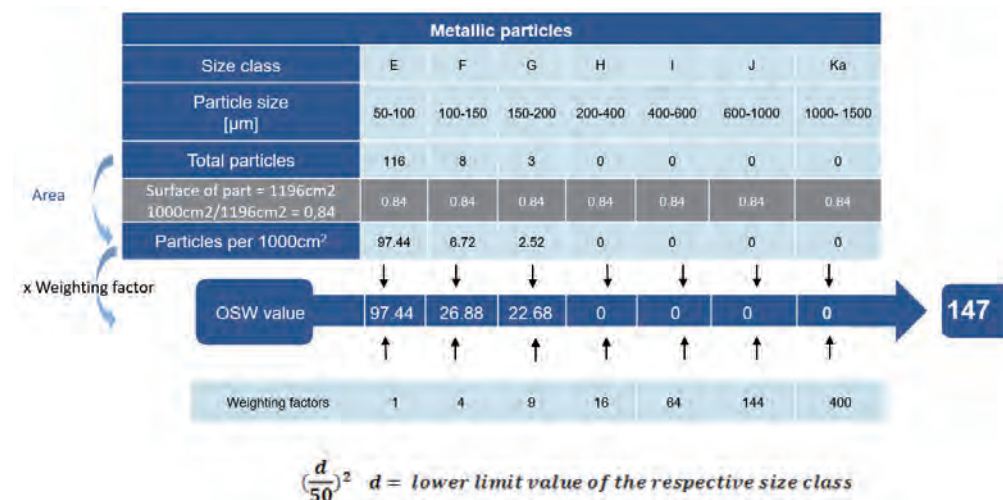
This need to provide evidence applies not only to environmental cleanliness, but also in particular to the products: For example, does an additional cleaning process achieve the desired effect?

This can be verified using the SCI (surface cleanliness index), which is a variation of the Illig value. It indicates the significant sum of particles. Like the Illig value, the SCI is a single numerical value which reflects the results of analysis for the relevant particle type.

**Fig. 11: Derivation of Illig value  
(scaling factor; see VDA 19 Part 2)**



**Fig. 12: Derivation of SCI**





The SCI differs from the Illig value only in the absence of scaling over time.

It is obtained by calculating the combined surface area of all test components in an analysis and then scaling up the number of particles per size class and type to 1000 cm<sup>2</sup>. Like the Illig value, the SCI uses the same weighting factors for each size class. These are derived from the lower limit  $d$  of the size class divided by 50 and squared. The number of particles in each size class per 1000 cm<sup>2</sup> is multiplied by this weighting factor to obtain the SCI per size class. The SCIs for each class are then added up to give the SCI for the complete analysis.

Note that in graphic representations the SCI, like the Illig value, should always be shown in relation to the largest particles so that a comprehensive statement can be made about the effect of the measure. Individual "outliers" in particular tend to get lost with a high SCI.

**The SCI is suitable for comparing** measures such as cleaned / not cleaned. The maximum particle lengths, which are normally defined in the specifications, give an indication of the extent to which the outlier rules and escalation strategy should be characterised.

It is advisable to use diagrams or a database as a visualisation tool to provide a quick overview of the results of a measure.

The informative value of a review of measures is directly related to the number of representative analyses. If one analytical value is worse after a measure (e.g. cleaning) than before, this is most likely due to the large standard deviation (see VDA 19 Part 1 Ch. 10.1).

Fig. 13: Evaluation of 7-pin HV strip connector

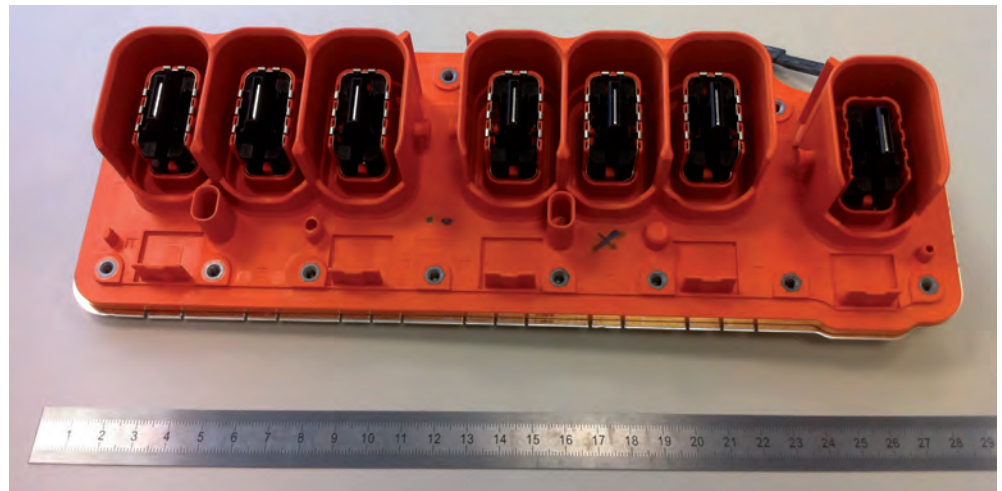
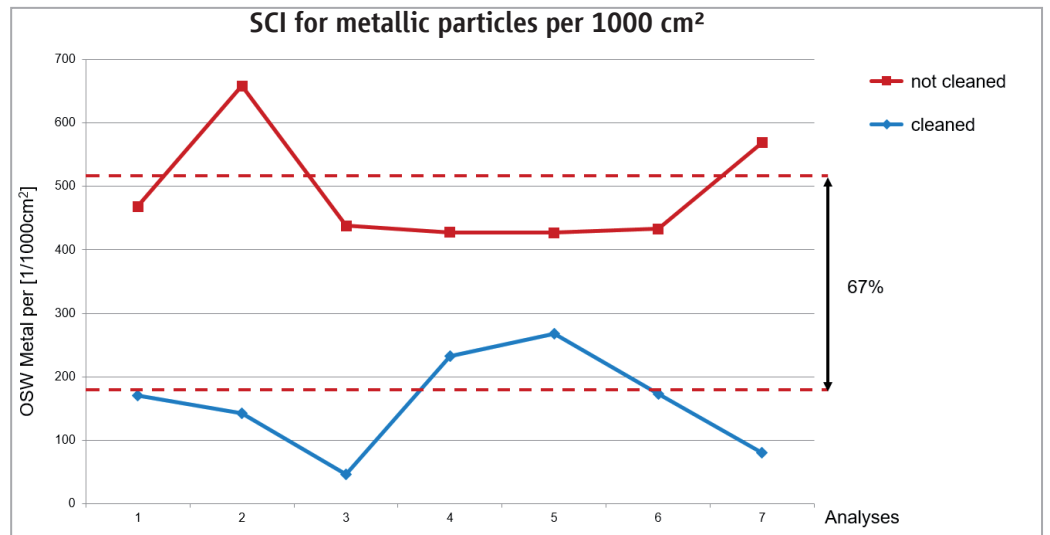
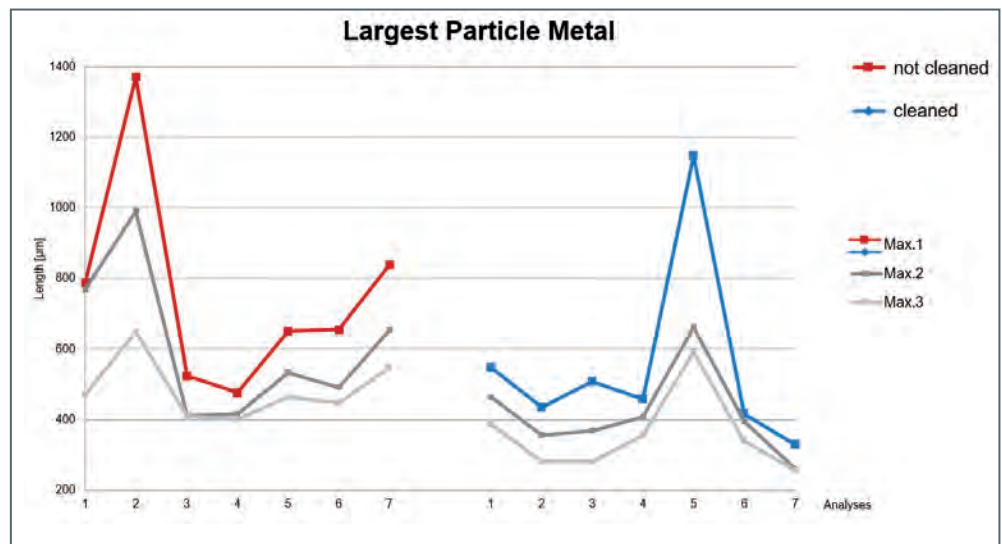


Fig. 14: Graph showing cleaning effect based on SCIs



Cleaning effect: 67%

Fig. 15: Comparison of the three largest particles





## Creating a database

Analytical reports can be transferred to a database manually or automatically.

Before a database can be set up, its scope must be defined. Experience shows that the spectrum of information increases over time; however, if every value from an analysis were to be transferred, the size of the database would increase very substantially.

Analyses are performed on the basis of individual cleanliness specifications. In most cases, analyses provide information specific to the given application only. For this reason, it is advisable to clarify (e.g. clarification form) which parameters should generally be stored.

If these parameters from the analyses are stored digitally in a database, they can be used for other purposes in the future.

Certain parameters from the analyses must be present in the database, depending on the requirements for the database. Ideally, a software program capable of performing evaluations of technical cleanliness is required.

Alternatively, an Excel database can be used. This can be compiled at low cost and with little programming expertise

Fig. 16: Structural levels of a database

	Option A	Option B	Option C	Option D
	In order to perform simple evaluations of the largest particles in length and width, the following data from the analyses are required:	In order to compare the degree of contamination of different analyses using OSW (MCV, TCV and FCV) and, if necessary, to specify the residual dirt mass, the following data must also be integrated into the database:	Extension by a separate data sheet "Direct comparison of test series":	Extension of the database by "comparison to customer standards":
Product-No.	x			
Designation	x			
Remark	x			
Reference for carrying out the analysis	x			
At least the three largest particles (per particle type) in length and width	x			
Number of particles in the respective size class and particle type of the inspection lot		x		
Residual dirt mass of the inspection lot		x		
Number of parts required per analysis		x		
Component surface per part		x		
Calculation operation that calculates an OSW value from the number of particles per class and, if applicable, the residual dirt mass (per analysis, per 1000 cm <sup>2</sup> or per component)		x		
Description of measures, e.g. type of cleaning, as well as process and material assignments			x	
Selection fields for selecting analyses for comparisons			x	
Additional data sheet to compare the selection			x	
Establishment of TecSa customer/supplier standards in the database				x

Fig. 17: Option A: Evaluation of the largest particles by length and width:

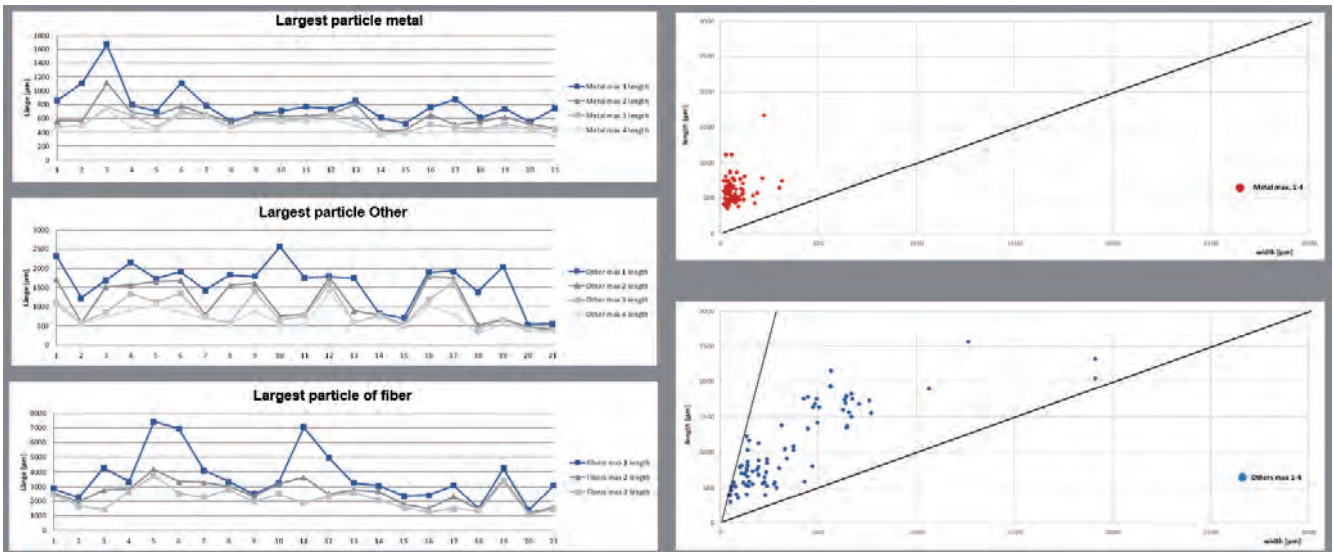


Fig. 18: Option B: Extension to include the degree of contamination: SCI

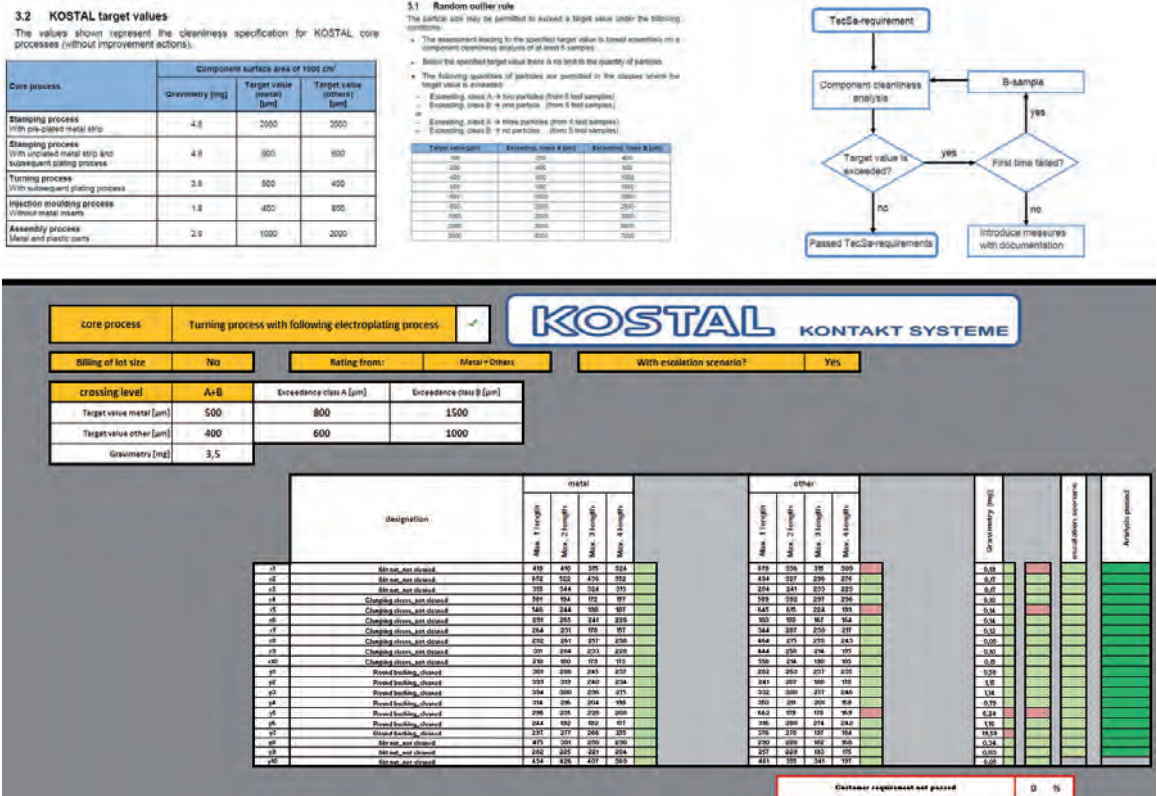


Fig. 19: Option C: Extension to include a separate data sheet "direct comparison of test series"



Option D: Extension of the database "to include ,comparison with customer standards"

Fig. 20: Example: LK3223 (Kostal Kontakt Systeme GmbH)



Factory standards on technical cleanliness are based on mathematical operations, so it is possible to integrate these into the database. Analyses can be automatically compared with standard specifications: e.g. particle type/s that is/are part of the specification, number of, the number of particles per size class, outlier rule, escalation strategy etc.

**Summary:**

The integration of an SCI enables statements to be made about the degree of contamination on the products themselves and comparisons with other test series if necessary. It is advisable to view this in the context of the "largest particles".

When the particle type/s of interest has/have been defined, a database is indispensable for providing retrospective/prospective statements. The greater the number of representative analyses available, the more accurate and informative the statements. Each analysis yields a substantial volume of data, but with the aid of a database an over-

view can easily be obtained by selecting the three "largest particles" / analysing them (per particle type) and calculating the corresponding SCI. This is all the more important when comparing the status quo with two different cleaning methods, for example. In this case, it is advisable to use at least five analyses per test series.

Then at the "press of a button" measures or cleanliness levels can be evaluated and compared with customer standards as required.

# 4 State of the art: Technical cleanliness in the electronics industry

## 4.1 Process flow (per cluster)

### 4.1.1 Electronics manufacturing cluster

Table 2: Electronics manufacturing cluster process flow

Process flow					Process steps
SMT single-sided	SMT+THT single-sided	SMT double-sided	SMT double-sided +THT (automatic)	SMT double-sided +THT (manual)	
X	X	X	X	X	Goods receipt
X	X	X	X	X	PCB marking
X	X	X	X	X	Paste application (stencil printing, dispensing, jetting) <sup>1)</sup>
(X)	(X)	(X)	(X)	(X)	SPI
	[X]	[X]	[X]	[X]	Dispensing (SMT glue)
X	X	X	X	X	SMD assembly
X	X	X	X	X	Soldering (reflow/vapour phase) <sup>1)</sup>
(X)	(X)	(X)	(X)	(X)	Inspection (MOI/AOI/AXI) <sup>2)</sup>
[X]	[X]	[X]	[X]	[X]	Rework
			X		THT assembly (automatic)
		X		X	Paste application (stencil printing, dispensing, jetting) <sup>1)</sup>
		(X)		(X)	SPI
		[X]	[X]	[X]	Dispensing (SMT glue)
		X	X	X	SMD assembly
			[X]		Curing glue
		X		X	Soldering (reflow/vapour phase) <sup>1)</sup>
		(X)	(X)	(X)	Inspection (MOI/AOI/AXI) <sup>2)</sup>
		[X]		[X]	Rework
	X			X	THT assembly (manual)
	X		X	X	THT soldering (wave/selective/stamp soldering)
	(X)		(X)	(X)	Inspection (MOI/AOI) <sup>2)</sup>
	[X]		[X]	[X]	Rework
[X]	[X]	[X]	[X]	[X]	Press-fit process
(X)	(X)	(X)	(X)	(X)	ICT
[X]	[X]	[X]	[X]	[X]	Depaneling (hand break, circular cutter, punching, routing, laser cutting) <sup>1)</sup>
[X]	[X]	[X]	[X]	[X]	Cleaning
[X]	[X]	[X]	[X]	[X]	Coating (dip, spray, tumbling)
(X)	(X)	(X)	(X)	(X)	Final inspection
[X]	[X]	[X]	[X]	[X]	Final assembly
X	X	X	X	X	Packaging

The table shows an example of five typical process flows in PCB assembly.

( ) requirement-specific measurement and test steps

[ ] product-specific process steps

<sup>1)</sup> only one procedure possible in each process step

<sup>2)</sup> several procedures possible in each process step

Process reduces particle count

Process is the main source of non-metallic particles

Process is the main source of metallic particles

### 4.1.2 Passive components cluster (e.g. for inductors and aluminium electrolytic capacitors)

Table 3: Inductors

1	Provide material
2	Attach contacts to core
3	Wind core
	Wind bobbin
	Wind air coil
	Selectively remove core coating
4	Strip wire ends
5	Tin wire ends
6	Bend wire ends
7	Mount coil in housing
	Mount air-core coil on core
	Mount bobbin on core
8	Connect (twisting) wire ends and contacts
	Clip wire ends into taps
9	Connect wire ends and contacts (solder, weld)
10	Clean component
11	Bond, pot or impregnate coil
	Embed component by injection or press-moulding
	Coat component
12	Assemble and glue second core
13	Cut wire ends to final length
14	Final inspection
15	Marking
16	Packaging

Process reduces particle count

Process is the main source of non-metallic particles

Process is the main source of metallic particles

Table 4: Aluminium electrolytic capacitors

1.	Goods receipt
2.	Production preparation
	Slit foil
3.	Cut paper
	Provide material
4.	Tack and wind
	Connect lead wires to foil (tacking)
5.	Wind foil and paper into a cylinder and secure with adhesive tape (winding)
	Assembly
	Impregnate element with electrolyte
6.	Push end seal on lead wires
	Assemble capacitor element with end seal in case and close
7.	Push printed sleeving over case and shrink-wrap
	Reform and measure
8.	Repair damage to the oxide layer of the anode foil caused by preceding processes (ageing)
	Determine (measure) electrical capacity of capacitor
9.	Printing (for capacitors without sleeving)
	Prepare capacitors according to specification
10.	Taping
	Lead cutting
11.	Forming
	Reverse polarity protection
12.	SMD
	Final inspection
13.	Packaging

Process is the main source of metallic particles

Process is the main source of non-metallic particles



### 4.1.3 Electromechanical components cluster

Electromechanical engineering comprises connectors should be analysed for the many technological areas. As representative electronics industry and in particular for electromechanical components, electrical PCB assemblies in this context.

**Tab. 5a, b: Stamped contact production/plastic production (housing) process flow**

<b>Component part process flow</b>	
<b>Sequence</b>	<b>Stamped contact production</b>
1	Goods receipt
2	Supply raw material as coiled strips or wires to stamping press
3	Stamp contacts and wind as strips interleaved with paper on reels or pallets
4	Electroplate blank contacts and wind interleaved with paper on reels or pallets. This step can be omitted for contacts made of pre-plated material.
5	Package in different types of outer packaging (e.g. wire mesh containers, boxes, PE bags)
6	Storage

<b>Component part process flow</b>	
<b>Sequence</b>	<b>Plastic production (e.g. housing)</b>
1	Goods receipt
2	Supply raw material as plastic granules to injection moulding machine
3	Inject molten plastic into mould tool and allow to cool
4	Eject/remove plastic housing from mould tool
5	Package as bulk goods or in layers in different types of outer packaging (e.g. with PE bags, lined)
6	Storage

**Table 6: Housing assembly process flow**

<b>Finished part process flow</b>	
<b>Sequence</b>	<b>Housing assembly</b>
1	Supply contacts on reel and housings in outer packaging to assembly line
2	Feed aligned housings into system
3	Feed contacts on reel to cutting station for separation
4	Insert individual contact element in plastic housing with positioning finger
5	Bend contact elements (if necessary)
6	Package finished connectors in layers interleaved with paper into cardboard/plastic boxes with trays and PE bags
7	Shipping

#### 4.1.4 PCB cluster

Table 7: PCB cluster process flow

Process low			
Sequence	Rigid circuit board	Flexible circuit board	Sequence
1	Goods receipt	Goods receipt	1
2	Inner layer production for multi-layer boards		
3		Drilling	2
4	Through-hole plating	[Trough-hole plating]	3
5	Photo imaging	Photo imaging	4
6	Electroplating		
7	Pickling	Pickling	5
8	AOI	Visual inspection	6
9	Solder mask	Cover layer tacking/lamination	7
		Bake process	8
		Cleaning	9
10	Surface finish	Surface finish	10
11	[V-scoring]	Depaneling	11
12	Milling	Punching/separating	12
13	Internal rinsing		
14	E-test	E-test	13
		Stiffener tacking/laminating	14
		Bake process	15
15	Final inspection	Final inspection	16
		[Cleaning]	17
16	Packaging/shipping (parts trays)	Packaging/shipping (blister, parts trays)	18

[ ] product-specific process step

Process reduces particle count

Process is the main source of metallic and non-metallic particles

#### 4.2 Technical cleanliness in the electronics industry – actual situation

Different electronic and electromechanical components, circuit boards and assemblies have been grouped in families based on similar designs and comparable manufacturing processes. To illustrate the particle count per size class, several analyses have been conducted for each component type.

The values in the tables indicate the level of cleanliness that can be achieved without

special cleaning processes (unless otherwise stated). Most values are determined from several cleanliness analyses – in some cases 20 or more.

The values have to be assessed as empirical values (best practice for the companies involved).

In the tables below, the particle count is indicated in relation to a surface area of 1000 cm<sup>2</sup>. The metallic particle count and the sum of all particles (without fibres) are indicated.

The empirical values in the tables are neither limit values nor typical values. Fixed limit values cannot be practically applied to component cleanliness; instead the values should be regarded as active control limits, with typical values often significantly lower than the tabular values. These values are exceeded only in rare cases or for specific components; generally they are undercut.

Note: The tables represent empirical values. They do not constitute limit values; due to the very wide variation in component complexity, limit values must be determined and agreed individually for each component/assembly.

Note:

- The previous Class K (>1000 µm) has only been partially expanded to include the revised classes defined in VDA 19 Part 1, Version 2015 K (1000–1500 µm), L (1500–2000 µm), M (2000–3000 µm) and N (>3000 µm) because some of the data available has been analysed using the old VDA 19 system.
- The particle count normally falls as the particle size increases. Sporadic exceptions to this rule can be found in the tables, which are based on real measurements. This could be related to the fact that certain processes favour the production of a particular particle size.

#### 4.2.1 Electronics manufacturing

**Table 8: Empirical data from electronics manufacturing cluster**

Empirical particle data from assembled PCBs <sup>2</sup> per 1000 cm <sup>2</sup> surface, based on particle class			
Particle size [µm]	Size classes	All particles	Metallic particles <sup>1)</sup>
50 ≤ x < 100	E	14500	1000
100 ≤ x < 150	F	2500	250
150 ≤ x < 200	G	800	90
200 ≤ x < 400	H	600	110
400 ≤ x < 600	I	70	17
600 ≤ x < 1000	J	20	13
1000 ≤ x	K	6	2

<sup>1)</sup> The count of metallic particles can be significantly higher on connectors with metal housings or heat sinks.

<sup>2)</sup> Without any cleaning process



## 4.2.2 Electronic components

### 4.2.2.1 Inductors

Tab. 9: Empirical data from inductors

Empirical particle data from <b>inductors</b> per 1000 cm <sup>2</sup> surface, based on particle class			
Particle size [µm]	Size classes	All particles	Metallic particles <sup>1)</sup>
50 ≤ x < 100	E	3500 <sup>3)</sup>	450 <sup>1)2)</sup>
100 ≤ x < 150	F	700 <sup>3)</sup>	150 <sup>1)2)</sup>
150 ≤ x < 200	G	250 <sup>3)</sup>	60 <sup>1)2)</sup>
200 ≤ x < 400	H	160 <sup>3)</sup>	30 <sup>1)</sup>
400 ≤ x < 600	I	20 <sup>3)</sup>	10 <sup>1)</sup>
600 ≤ x < 1000	J	8 <sup>3)</sup>	0.00 <sup>1)</sup>
1000 ≤ x	K	3 <sup>3)</sup>	0.00

<sup>1)</sup> The count of metallic particles on components with lead frame or metal housings is likely to be higher than indicated in the table

<sup>2)</sup> The count of metallic particles on components with more than 10 open end pins is likely to be higher than indicated in the table

<sup>3)</sup> The count of non-metallic particles on molded components is likely to be higher than indicated in the table

### 4.2.2.2 Capacitors

Table 10: Empirical data from aluminium electrolytic capacitors

Empirical particle data from <b>aluminium electrolytic capacitors</b> per 1000 cm <sup>2</sup> surface, based on particle class			
Particle size [µm]	Size classes	All particles	Metallic particles <sup>1)</sup>
50 ≤ x < 100	E	7500	2500
100 ≤ x < 150	F	1500	550
150 ≤ x < 200	G	360	200
200 ≤ x < 400	H	240	150
400 ≤ x < 600	I	45	30
600 ≤ x < 1000	J	6	5
1000 ≤ x	K	0.00	0.00

**Table 11: Empirical data from tantalum capacitors**

Empirical particle data from <b>tantalum capacitors</b> per 1000 cm <sup>2</sup> surface, based on particle class			
Particle size [μm]	Size classes	All particles	Metallic particles <sup>1)</sup>
$50 \leq x < 100$	E	1600	150
$100 \leq x < 150$	F	500	60
$150 \leq x < 200$	G	30	60
$200 \leq x < 400$	H	80	20
$400 \leq x < 600$	I	0.00	0.00
$600 \leq x < 1000$	J	0.00	0.00
$1000 \leq x < 1500$	K	0.00	0.00
$1500 \leq x < 2000$	L	0.00	0.00
$2000 \leq x < 3000$	M	0.00	0.00
$3000 \leq x$	N	0.00	0.00

#### 4.2.2.3 Chip components

**Table 12: Empirical data from chip components**

Empirical particle data from <b>resistors, MLCCs, varistors, NTCs, PTCs</b> per 1000 cm <sup>2</sup> surface, based on particle class			
Particle size [μm]	Size classes	All particles	Metallic particles <sup>1)</sup>
$50 \leq x < 100$	E	3000	400
$100 \leq x < 150$	F	1200	140
$150 \leq x < 200$	G	300	30
$200 \leq x < 400$	H	120	5
$400 \leq x < 600$	I	30	0.00
$600 \leq x < 1000$	J	5	0.00
$1000 \leq x < 1500$	K	0.00	0.00
$1500 \leq x < 2000$	L	0.00	0.00
$2000 \leq x < 3000$	M	0.00	0.00
$3000 \leq x$	N	0.00	0.00

#### 4.2.2.4 Shunt-resistors

**Table 13: Empirical data from shunts**

Empirical particle data from shunts per 1000 cm <sup>2</sup> surface, based on particle class			
Particle size [µm]	Size classes	All particles	Metallic particles <sup>1)</sup>
$50 \leq x < 100$	E	1300	600
$100 \leq x < 150$	F	200	150
$150 \leq x < 200$	G	60	50
$200 \leq x < 400$	H	60	30
$400 \leq x < 600$	I	20	10
$600 \leq x < 1000$	J	30	0.00
$1000 \leq x < 1500$	K	10	0.00
$1500 \leq x < 2000$	L	0.00	0.00
$2000 \leq x < 3000$	M	0.00	0.00
$3000 \leq x$	N	0.00	0.00

#### 4.2.2.4 Quartz

**Table 14: Empirical data from quartz**

Empirical particle data from quartz per 1000 cm <sup>2</sup> surface, based on particle class			
Particle size [µm]	Size classes	All particles	Metallic particles <sup>1)</sup>
$50 \leq x < 100$	E	2800	400
$100 \leq x < 150$	F	600	90
$150 \leq x < 200$	G	250	20
$200 \leq x < 400$	H	230	5
$400 \leq x < 600$	I	10	0.00
$600 \leq x < 1000$	J	5	0.00
$1000 \leq x < 1500$	K	5	0.00
$1500 \leq x < 2000$	L	0.00	0.00
$2000 \leq x < 3000$	M	0.00	0.00
$3000 \leq x$	N	0.00	0.00

#### 4.2.2.6 Semiconductors

**Table 15: Empirical data from semiconductors**

Empirical particle data from semiconductors per 1000 cm <sup>2</sup> surface, based on particle class			
Particle size [μm]	Size classes	All particles	Metallic particles <sup>1)</sup>
50 ≤ x < 100	E	8000	100
100 ≤ x < 150	F	1600	20
150 ≤ x < 200	G	600	0.00
200 ≤ x < 400	H	320	0.00
400 ≤ x < 600	I	0.00	0.00
600 ≤ x < 1000	J	0.00	0.00
1000 ≤ x < 1500	K	0.00	0.00
1500 ≤ x < 2000	L	0.00	0.00
2000 ≤ x < 3000	M	0.00	0.00
3000 ≤ x	N	0.00	0.00

#### 4.2.3 Electromechanical components

##### 4.2.3.1 Metallic components – stamping from pre-treated strip stock

**Table 16: Empirical data from metallic components – stamping from pre-treated strip stock**

Empirical particle data from metallic components – stamping from pre-treated strip stock per 1000 cm <sup>2</sup> surface, based on particle class			
Particle size [μm]	Size classes	All particles	Metallic particles <sup>1)</sup>
100 ≤ x < 150	F	3000	2000
150 ≤ x < 200	G	1200	900
200 ≤ x < 400	H	1000	850
400 ≤ x < 600	I	160	150
600 ≤ x < 1000	J	80	75
1000 ≤ x < 1500	K	20	13
1500 ≤ x < 2000	L	3	3
2000 ≤ x < 3000	M	1	1
3000 ≤ x	N	0.02	0.00

#### 4.2.3.2 Metallic components – stamping of contacts from untreated strip stock

**Table 17: Empirical data from metallic components – stamping of contacts from untreated strip stock and subsequent electroplating process**

Empirical particle data from <b>metallic components – stamping of contacts from untreated strip stock</b> per 1000 cm <sup>2</sup> surface, based on particle class			
Particle size [µm]	Size classes	All particles	Metallic particles <sup>1)</sup>
100 ≤ x < 150	F	9000	3000
150 ≤ x < 200	G	3000	1000
200 ≤ x < 400	H	1500	500
400 ≤ x < 600	I	160	12
600 ≤ x < 1000	J	20	4
1000 ≤ x < 1500	K	30	0.04
1500 ≤ x < 2000	L	0.52	0.20
2000 ≤ x < 3000	M	0.76	0.00
3000 ≤ x	N	0.03	0.00

#### 4.2.3.3 Metallic components – turning of pins

**Table 18: Empirical data from metallic components – turning of pins and subsequent electroplating process**

Empirical particle data from <b>metallic components – turning of pins</b> and subsequent electroplating process per 1000 cm <sup>2</sup> surface, based on particle class			
Particle size [µm]	Size classes	All particles	Metallic particles <sup>1)</sup>
50 ≤ x < 100	E	3900	3300
100 ≤ x < 150	F	360	310
150 ≤ x < 200	G	45	37
200 ≤ x < 400	H	43	31
400 ≤ x < 600	I	7	7
600 ≤ x < 1000	J	0.00	0.00
1000 ≤ x	K	0.00	0.00

#### 4.2.3.4 Pure plastic parts

**Table 19: Empirical data from pure plastic parts**

Empirical particle data from <b>pure plastic parts</b> per 1000 cm <sup>2</sup> surface, based on particle class			
Particle size [µm]	Size classes	All particles	Metallic particles <sup>1)</sup>
100 ≤ x < 150	F	900	120
150 ≤ x < 200	G	300	20
200 ≤ x < 400	H	200	10
400 ≤ x < 600	I	20	0.78
600 ≤ x < 1000	J	10	0.00
1000 ≤ x < 1500	K	2	0.00
1500 ≤ x < 2000	L	2	0.00
2000 ≤ x < 3000	M	2	0.00
3000 ≤ x	N	0.06	0.00

#### 4.2.3.5 Joined strip connectors

**Table 20: Empirical data from joined strip connectors**

Empirical particle data from the <b>assembly of metal and plastic parts – joined strip connectors</b> per 1000 cm <sup>2</sup> surface, based on particle class			
Particle size [µm]	Size classes	All particles	Metallic particles <sup>1)</sup>
100 ≤ x < 150	F	650	300
150 ≤ x < 200	G	200	80
200 ≤ x < 400	H	190	40
400 ≤ x < 600	I	30	4
600 ≤ x < 1000	J	12	1
1000 ≤ x < 1500	K	4	0.35
1500 ≤ x < 2000	L	1	0.05
2000 ≤ x < 3000	M	1	0.03
3000 ≤ x	N	0.02	0.00

#### 4.2.3.6 High-voltage connectors

**Table 21: Empirical data from high-voltage connectors (typically shielded)**

Empirical particle data from the assembly of metal and plastic parts – high-voltage connectors (typically shielded) per 1000 cm <sup>2</sup> surface, based on particle class			
Particle size [µm]	Size classes	All particles	Metallic particles <sup>1)</sup>
100 ≤ x < 150	F	4000	2000
150 ≤ x < 200	G	1500	700
200 ≤ x < 400	H	1200	500
400 ≤ x < 600	I	150	100
600 ≤ x < 1000	J	70	40
1000 ≤ x < 1500	K	20	8
1500 ≤ x < 2000	L	7	2
2000 ≤ x < 3000	M	4	1
3000 ≤ x	N	3	0.00

#### 4.2.3.2 Non-metallic components

**Table 22: Empirical data from the assembly process of non-metallic components**

Empirical particle data from the assembly of non-metallic components per 1000 cm <sup>2</sup> surface, based on particle class			
Particle size [µm]	Size classes	All particles	Metallic particles <sup>1)</sup>
100 ≤ x < 150	F	2800	30
150 ≤ x < 200	G	1000	0.10
200 ≤ x < 400	H	900	0.06
400 ≤ x < 600	I	80	0.06
600 ≤ x < 1000	J	30	0.00
1000 ≤ x < 1500	K	15	0.00
1500 ≤ x < 2000	L	0.00	0.00
2000 ≤ x < 3000	M	7	0.00
3000 ≤ x	N	0.00	0.00

## 4.2.4 Metal housings

### 4.2.4.1 Die-cast aluminium housing

Tab. 23: Empirical data from die-cast aluminium housing

Empirical particle data from <b>die-cast aluminium housing</b> per 1000 cm <sup>2</sup> surface, based on particle class			
Particle size [µm]	Size classes	All particles	Metallic particles <sup>1)</sup>
100 ≤ x < 150	F	1100	700
150 ≤ x < 200	G	310	230
200 ≤ x < 400	H	230	200
400 ≤ x < 600	I	50	47
600 ≤ x < 1000	J	30	28
1000 ≤ x < 1500	K	10	10
1500 ≤ x < 2000	L	4	4
2000 ≤ x < 3000	M	3	3
3000 ≤ x	N	1	1

## 4.2.5 Packaging

### 4.2.5.1 Deep-drawn trays (new)

Tab. 24: Empirical data from deep-drawn trays (new)

Empirical particle data from <b>deep-drawn trays (new)</b> per 1000 cm <sup>2</sup> surface, based on particle class			
Particle size [µm]	Size classes	All particles	Metallic particles <sup>1)</sup>
100 ≤ x < 150	F	600	20
150 ≤ x < 200	G	200	3
200 ≤ x < 400	H	150	2
400 ≤ x < 600	I	20	0.15
600 ≤ x < 1000	J	10	0.00
1000 ≤ x < 1500	K	6	0.00
1500 ≤ x < 2000	L	2	0.00
2000 ≤ x < 3000	M	0.00	0.00
3000 ≤ x	N	0.00	0.00



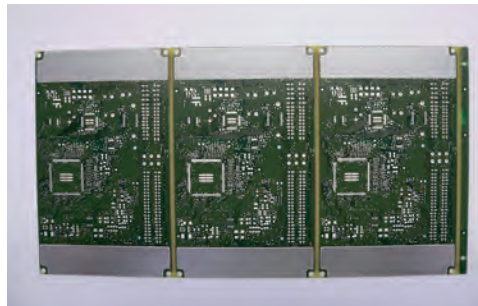
#### 4.2.6 Printed circuit boards (PCBs)

In a PCB cluster (unassembled), a distinction is made between rigid (double-sided and multilayer boards) and flexible circuit boards.

**Fig. 21: Flexible circuit board**



**Fig. 22: Rigid circuit board**



Flexible circuit boards can be partially reinforced using punched metal and/or plastic stiffeners. This may increase the theoretical number of metal and plastic particles. The theoretical number of metallic and plastic particles may also increase on rigid circuit boards with special features such as copper or aluminium heat sinks, depth milling, cavities, etc.

Flexible and rigid circuit boards are usually subjected to rigorous electrical testing, which minimizes the risk of electrical functional failures due to conducting particles.

**Table 25: Empirical data from flexible PCBs without cleaning step**

Empirical particle data <sup>1)</sup> from flexible PCBs without cleaning step per 1000 cm <sup>2</sup> surface, based on particle class			
Particle size [µm]	Size classes	All particles	Metallic particles <sup>1)</sup>
50 ≤ x < 100	E	3000 <sup>2)</sup>	400 <sup>3)</sup>
100 ≤ x < 150	F	400 <sup>2)</sup>	40 <sup>3)</sup>
150 ≤ x < 200	G	50 <sup>2)</sup>	10 <sup>3)</sup>
200 ≤ x < 400	H	40 <sup>2)</sup>	10 <sup>3)</sup>
400 ≤ x < 600	I	4 <sup>2)</sup>	4 <sup>3)</sup>
600 ≤ x < 1000	J	0.00 <sup>2)</sup>	0.00 <sup>3)</sup>
1000 ≤ x	K	0.00 <sup>2)</sup>	0.00 <sup>3)</sup>

<sup>1)</sup> The indicated values are mean values of different circuit board designs with different metallic and non-metallic stiffeners

<sup>2)</sup> The count of non-metallic particles on PCBs with plastic stiffeners is likely to be higher than indicated in the table

<sup>3)</sup> The count of metallic particles on PCBs with punched metal stiffeners is likely to be higher than indicated in the table

**Table 26: Empirical data from bare, flexible PCBs with cleaning step**

Empirical particle data <sup>1)</sup> from bare, flexible PCBs with cleaning step per 1000 cm <sup>2</sup> surface, based on particle class			
Particle size [µm]	Size classes	All particles	Metallic particles <sup>1)</sup>
50 ≤ x < 100	E	700 <sup>2)</sup>	300 <sup>3)</sup>
100 ≤ x < 150	F	200 <sup>2)</sup>	50 <sup>3)</sup>
150 ≤ x < 200	G	40 <sup>2)</sup>	10 <sup>3)</sup>
200 ≤ x < 400	H	20 <sup>2)</sup>	10 <sup>3)</sup>
400 ≤ x < 600	I	0.00 <sup>2)</sup>	0.00 <sup>3)</sup>
600 ≤ x < 1000	J	0.00 <sup>2)</sup>	0.00 <sup>3)</sup>
1000 ≤ x	K	0.00 <sup>2)</sup>	0.00 <sup>3)</sup>

<sup>1)</sup> The indicated values are mean values of different circuit board designs with different metallic and non-metallic stiffeners

<sup>2)</sup> The count of non-metallic particles on PCBs with plastic stiffeners is likely to be higher than indicated in the table

<sup>3)</sup> The count of metallic particles on PCBs with punched metal stiffeners is likely to be higher than indicated in the table

**Tab. 27: Empirical data from bare, rigid PCBs**

Empirical particle data from bare, rigid PCBs per 1000 cm <sup>2</sup> surface, based on particle size			
Particle size [µm]	Size classes	All particles	Metallic particles <sup>1)</sup>
100 ≤ x < 150	F	140	30
150 ≤ x < 200	G	50	15
200 ≤ x < 400	H	20	5
400 ≤ x < 600	I	6	3
600 ≤ x < 1000	J	2	0.00
1000 ≤ x < 1500	K	0.00	0.00
1500 ≤ x < 2000	L	0.00	0.00
2000 ≤ x < 3000	M	0.00	0.00
3000 ≤ x	N	0.00	0.00

## 4.3 Determining potential particle sources in production areas

Analysis of a part's component cleanliness provides information on the number and size distribution of extracted particles, and often the number and size distribution of metallic shiny particles as well. The particle source, however, is not immediately identifiable.

Nevertheless, it is essential to know the particle sources and relevant influencing factors to minimise particulate contamination. VDA 19 Part 2 deals with this subject.

### 4.3.1 Particle generation

Particles are distinguished according to their source:

- non-specific particles present in manufacturing areas (dirt, dust, skin cells, minerals/salts, soot...)
- particles originating from product elements
  - from the product itself
  - from adjacent products

Particles originating from a product have either been introduced by externally supplied parts or produced during the process steps.

Dust is always present in any manufacturing facility. Typically, 6 mg of dust is produced per square metre and day; Humans, for instance, shed 1 -2 g of skin cells per day on average.

Other possible sources of dust are:

- fibres, lint  
(from clothing, textiles, paper, cardboard...)
- plant parts such as pollen and flower particles
- live and dead bacteria
- mold
- remains (dead bodies, shed skin, excrement) from other microorganisms
- rock particles  
(road debris, sand drift...)
- particulate matter (soot from internal combustion engines, heating systems, industrial fumes and fires)

Although the percentage of mites and similar organisms is much lower in industrial dust, additional wear debris is created in production facilities by rotating equipment such as motors (carbon), belts (rubber), brakes (asbestos) as well as fumes (hot oil) and dust (grinding).

The production of metallic particles is a process that can rarely be controlled and hence regulated. In most cases, particles are generated randomly and governed by few principles or laws. The prevention of particles should always take priority over their subsequent removal.

But first, they have to be identified, e.g. by REM/EDX. Light microscopy is also an established method of identifying particles by shape and colour.

### 4.3.2 Electronics manufacturing cluster

Electrically conductive particles are considered to be particularly critical due to their ability to impair the performance of electronic components. However, non-metallic particles may also result in failures, e.g. leaking housings, contact problems etc., since components are increasingly integrated into complete systems.

### Potential metallic particle sources:

- carry-over from upstream processes (PCB, components, housings)
- carry-over of solder paste during application process (contaminated solder mask bottom, splatters during solder jetting process) → loose solder balls
- solder splatter during the melting process → loose solder balls
- flux residue during THT soldering
- residue during repair soldering → loose solder balls
- chip formation during press-fit process (contacts, connectors, screening shields, etc.)
- chip formation during test system connection (bed-of-nails tester, flying probe, plug-in connections, etc.)
- chip formation during system assembly (burrs on injection-moulded parts, bolted connections)
- etc.

### Potential non-metallic particle sources:

- contaminated manufacturing systems
- PCB material residue during depaneling (glass fibre fragments, milling dust)
- smoke residue during laser depaneling
- chip formation during system assembly (plastic chips, etc.)
- packaging material (boxes, polystyrene)
- etc.

## 4.3.3 Passive components cluster

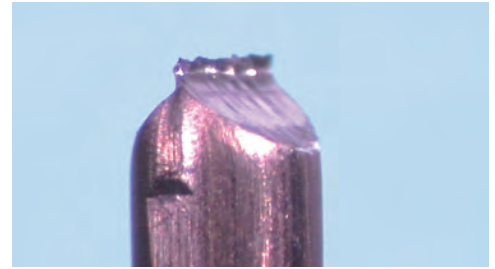
### Metallic particles

The majority of components use conductors or connecting elements that are typically made of copper or copper alloys. Coatings consisting of tin or tin alloys with partial pre-nickel plating are often used to ensure solderability.

A higher copper particle count occurs when wires are used, e.g. for wound elements

(inductive components). When a wire is cut, a flush-cut area and a fracture area are created at the cut face. Burrs frequently form in the fracture area. These may, or may not, adhere tightly to the wire ends.

**Fig. 23: Burr formation on copper wire (D = 2.25 mm) after use of wire-cutter**



The condition and wear of the cutting tool greatly influence the formation of burrs.

The photos clearly show that in this case the maximum length of possible particles corresponds to the length of the cut edge.

**Fig. 24,25: Particles generated by wire cutting D = 1.8 mm (tinned copper)**

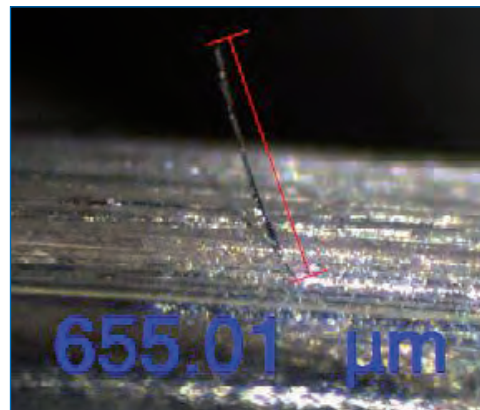


**Fig. 26: Particle (tin) adhering to a tinned copper wire D = 2.25 mm**



**Fig. 27: Enlarged photo depicting particle length measurement**

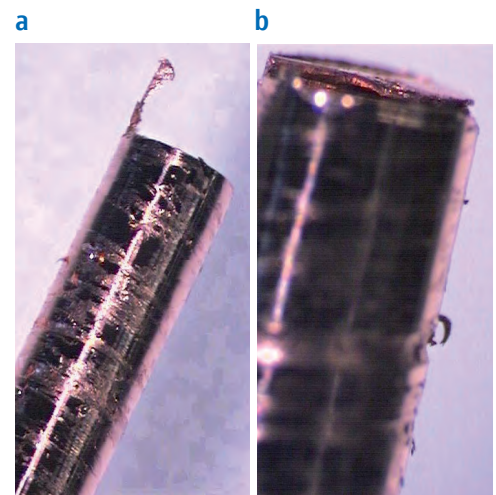
**Fig. 28: Hair-like particle (tin whiskers) chipped off a tinned wire (655 μm long)**



If tinned wires are used, lots of swarf and metal dust can be found on the wire material supplied. Chips may form during winding and re-routing processes and are sometimes pressed back onto the wire.

Chips automatically form during the mechanical stripping (rotational milling) of round enamel wires. They stick to the base material due to the softness of copper.

**Fig. 29: Milled enamel wires**



Many components use solder or tin to attach the leads to the pin, which requires hot tin dipping with molten solder. To ensure good wetting, they must be moistened with flux in advance.

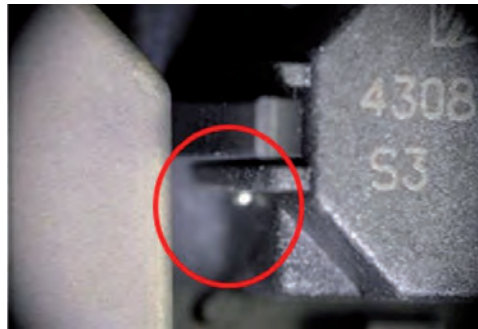
The flux uses a carrier material (water, solvent) that evaporates immediately on immersion in the solder. This creates gas bubbles, causing solder balls to “fly off”.

This effect is known to occur during PCB soldering using wave-soldering systems. The solder splatters or balls are usually catapulted several centimetres away and often stick to adjacent surfaces.

Sometimes they even melt into plastic material and are burned it.



**Fig. 30, 31: Molten solder ball fused to plastic housing**



These solder balls can also be found squeezed flat on housings as carry-over particles. Since tin is soft, small balls on table tops or between tools are pressed flat and easily adhere to rough surfaces.

The number of tin balls can be reduced by shielding adjacent areas with a splash guard during the tin plating process.

Inductive components normally have a magnetic core, which means that particles may accumulate there. Ferrites (iron-oxide based ceramics), for example, are breakable and have sharp edges and burrs, which chip off easily on contact. Lots of ferrite dust as well as particles of several millimetres can be found at core assembly stations.

Ferrites are typically semiconductors, allowing electrical currents to flow and thus also causing short-circuits.

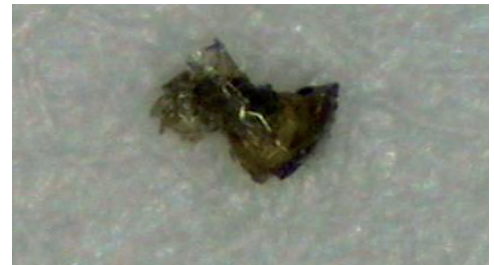
**Fig. 32: Ferrite particle, identified as metallic (419  $\mu\text{m}$ )**



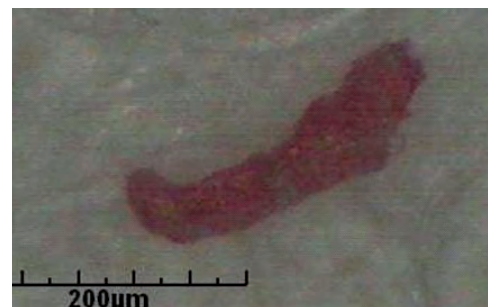
**Fig. 33: Ferrite particle, identified as non-metallic (558  $\mu\text{m}$ )**



**Fig. 34: Non-metallic particle, probably burr or plastic residue (217  $\mu\text{m}$ )**



**Fig. 35: Non-metallic particle, probably pink polystyrene packaging material**



The ferrite particle in Fig. 32 is a good example of the difficulties in detecting metal with optical analysis methods. Due to the difference in lustre (compared to Fig. 33), it is incorrectly classified during the automatic metal/non-metal selection.

Soft magnetic cores of amorphous and nanocrystalline materials consist of strip stock, which tends to chip easily. Since the cores are often encapsulated in plastic, direct chipping is no longer possible. However, the casings must be cleaned on the outside since the processing area is prone to contamination introduced by transportation or employees.

#### 4.3.4 Electromechanical components cluster

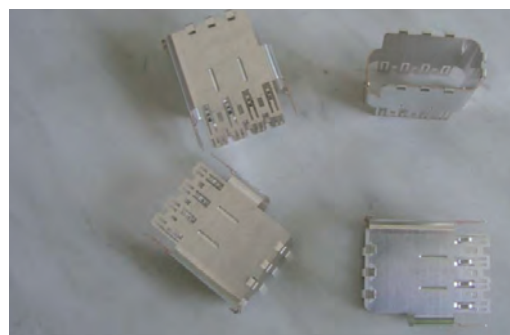
Electrically conductive particles are classified as primarily critical to the performance of electrical connectors.

Potential sources of metallic particles:

- carry-over from previous processes
- stamping process (cutting/ripping, bending, re-routing, further transport, burr formation)
- transport, routing during/after winding
- separation of metallic components on the belt
- shear stress during joining processes
- peeling during bending processes
- abrasion during or caused by the handling of metallic components
- vibrations during transportation
- etc.

#### Metallic components stamped from pre-treated strip stock

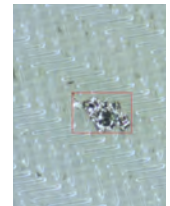
Fig. 36,37,38: Shielding plate



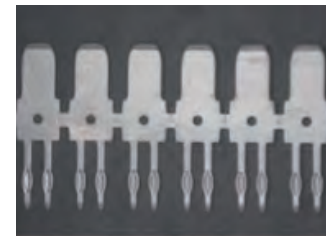
#### Metallic components – stamping of contacts from pretreated strip stock and subsequent electroplating process

Fig. 39, 40, 41, 42: Stamped contacts

Metallic particle 373 µm

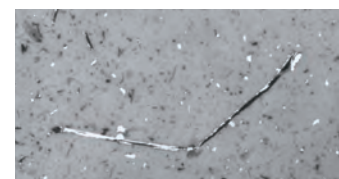


Metallic particle 265 µm



The parts undergo a cleaning stage during electroplating, which has a positive effect on component cleanliness.

Metallic particle 2176 µm

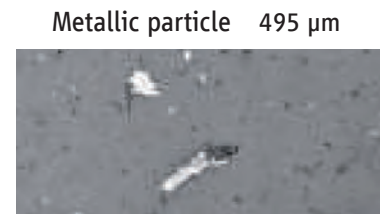
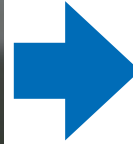


Metallic particle 1623 µm



**Metallic components – turning of pins and subsequent electroplating process**

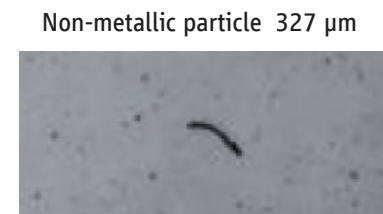
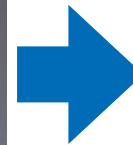
**Fig. 43, 44, 45: Connector pin**



Metallic particle 319  $\mu\text{m}$

**Injection molding process (without metal inserts)**

**Fig. 46, 47, 48: Connector housing**

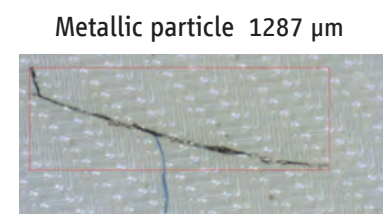
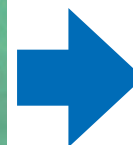


Non-metallic particle 261  $\mu\text{m}$

Tool wear is normally low during injection moulding and has no significant impact on component cleanliness.

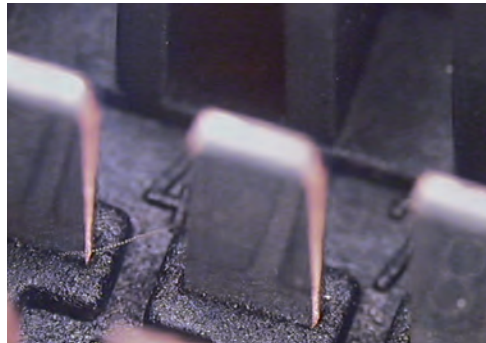
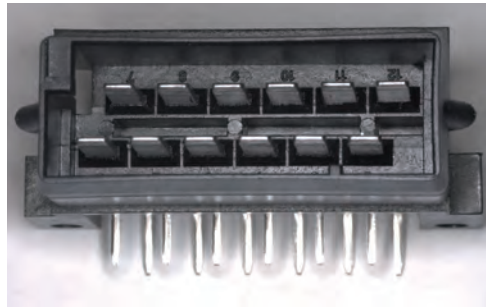
**Assembly process of metal and plastic parts**

**Fig. 49, 50, 51:  
58-pin connector housing**



Metallic particle 421  $\mu\text{m}$

Fig. 52, 53: 12-pin connector with bridged contacts



The retrofitting of cleaning stations (mechanical and/or fluid) calls for substantial effort and expenditure and significantly increases manufacturing costs, but is sometimes needed to improve or achieve the required level of component cleanliness.

#### 4.3.5 PCB cluster

Particle generation cannot be avoided during circuit board manufacturing, and especially when defining contours and processing punched metallic and non-metallic stiffeners.

Fig. 54: Plastic particles + fibres

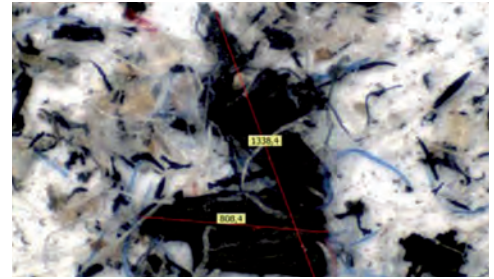


Fig. 55: Plastic particles

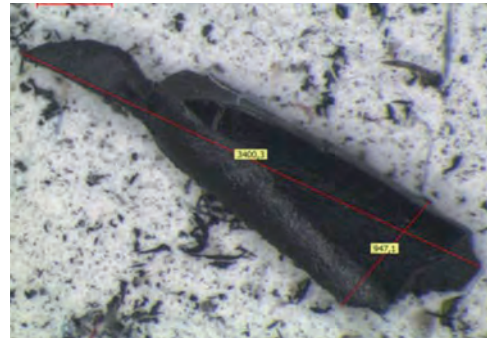


Fig. 56: Metallic particle



Potential sources of metallic particles:

- cross-contamination due to uncleaned systems/processes
- punching process (re-routing, further transport, burr formation)
- shear stress during joining processes
- abrasion during or caused by the handling of metallic components
- transportation in contaminated packaging
- etc.

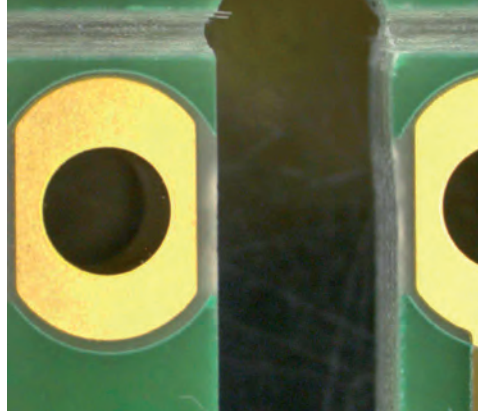
The smaller the metallic particles, the better they adhere to the circuit board due to electrostatic forces. Metallic and non-metallic particles can – if necessary – be largely, but not entirely, removed with additional cleaning steps. The cleaning processes require more effort and significantly increase manufacturing costs.

Particle generation may also be influenced by the design and construction of a PCB. The production and deposition of metallic and non-metallic particles can thus be reduced in advance.

**Design guidelines for reducing particles:**

- V-scoring of circuit board panels
  - Milling lines should not cross V-scoring lines
  - V-scoring lines should not overlap milled areas

**Fig. 57: Milling crosses V-scoring line**

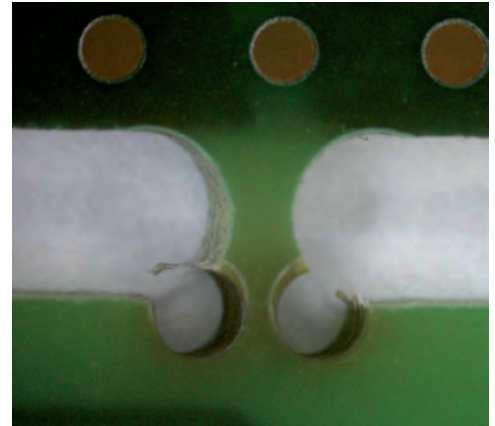


**Fig. 58: V-scoring line on milling edge**



- Milling of holes for predetermined breaking points produces non-metallic particles

**Fig. 59: Chip formation in milled hole**



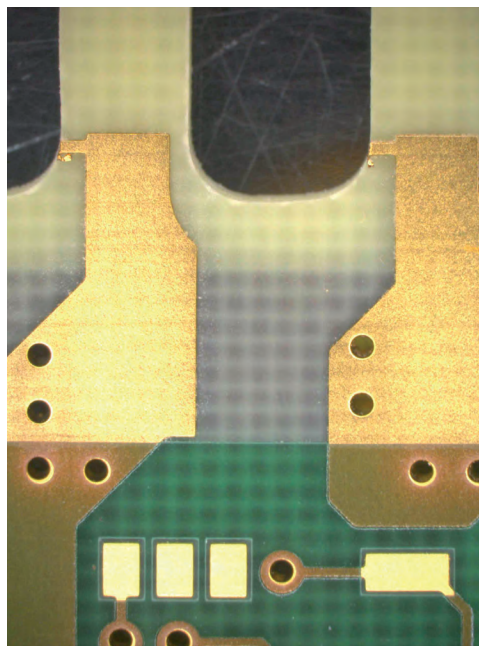
- Copper areas on the circuit board contour generate metallic particles, e.g. during edge plating or when cutting the connection for electroplated gold pins



**Fig. 60: Edge plating**

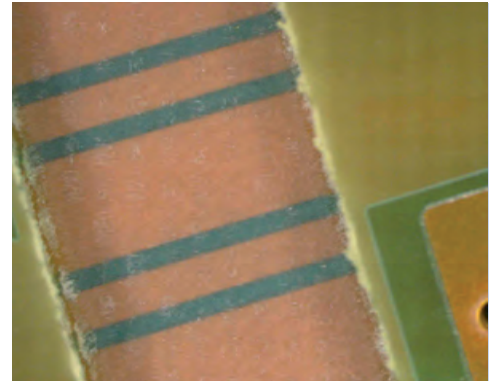


**Fig. 61: Connections for electroplated gold areas**



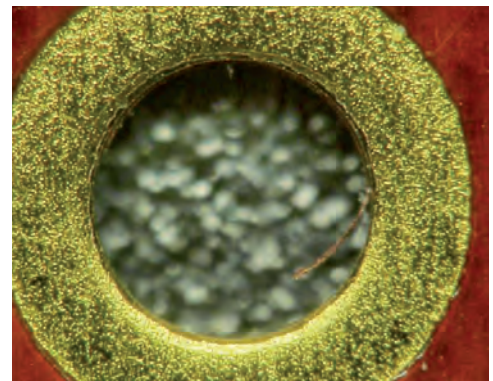
- Cavities, recesses and deep millings produce non-metallic particles.

**Fig. 62: Deep milling**



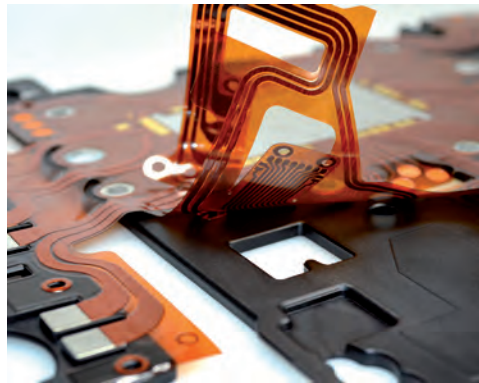
- Avoid stamping metallic areas (e.g. nickel, gold, tin) to reduce chip formation

**Fig. 63: Chip formation caused by stamping**



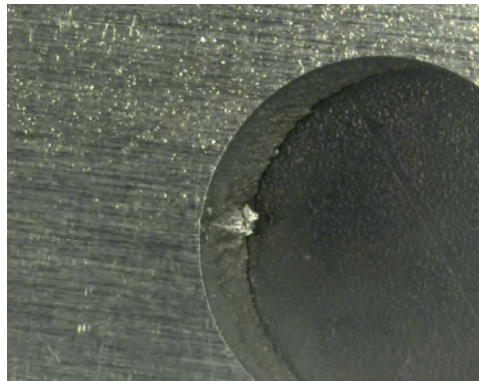
- Avoid undercuts: Particles accumulate in undercuts and are difficult to remove even with an additional cleaning step

**Fig. 64: Flexible circuit board with undercut**



- Ensure burr and damage-free processing of punched metallic elements to reduce particulate contamination

**Fig. 65: Punching burr in hole**



**Fig. 66: Punching burr**

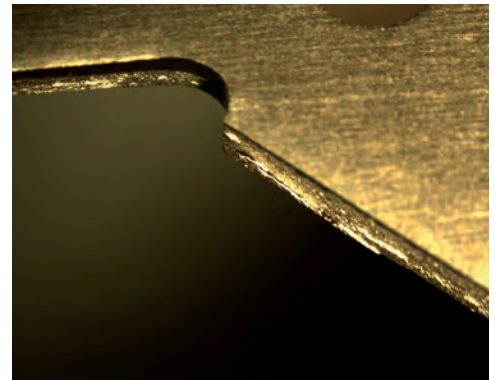


**Fig. 67: Damaged metallic stiffener**



- The pickling process loosens stamping residue along the metal edges and so redefines the details of the stamped edge.

**Fig. 68: Stamping residue along stamped edge**



**Fig. 69: Stamping residue loosened by pickling bath**



- Ensure burr and damage-free processing of plastic elements to reduce particle contamination

Fig.70: Plastic element with burr



Fig. 71: Particles on externally supplied plastic elements



#### 4.4 Cleanliness-controlled design and process selection

##### Aspects of cleanliness-controlled design/production with regard to metallic particles

According to our present understanding, most particles are generated during the processing of components and assemblies (approx. 80%) and only a fraction (approx. 20%) are due to environmental influences.

Since it is not possible to address every possible malfunction and manufacturing process due to the sheer complexity of the subject (see Chapter 2.3 and Chapter 4.1), the aim here is to focus on metallic particles.

To produce a product with the minimum particle contamination possible, the manufacturing processes best suited to achieving this must be defined preemptively in the product and process analysis. In other words: how and with what can the product be configured to achieve the lowest possible potential particle contamination?

#### 1. Product

- The component design should be sufficiently robust to ensure that the component is able to tolerate a certain level of contamination without impairing performance. For example, the clearance between electrical potentials and air gaps and creepage distances should be as generous as possible and electrical potentials should be physically separated from one another, not placed side-by-side. If this is not possible, areas at risk must be protected (protective coating, partitions, housing...).
- It should be possible to remove particles easily. The component should undergo an effective final cleaning stage before commissioning. Concealed and contorted structures impede or prevent this process.
- Stamped products have a high particle load, which is reduced to a minimum during electroplating processes. Stamped products which do not undergo a subsequent galvanic cleaning process should be re-cleaned if necessary.
- Joining processes can generate particles; for example, contact holders with a high glass fibre content can produce chips when the contacts are mounted to the relatively soft tin surfaces. Contact surfaces should be as small as possible and provision made from re-cleaning.

- Loose particle reduction. A vertically mounted flat assembly encourages self-cleaning since the particles slide off. If these loose particles are removed completely or at least captured in bags, they are rendered harmless to the system.
- Ideally, replace bare die chips with housed chips.
- Use BGAs with underfill.
- Restrict or completely eliminate the use of components typically associated with a high particle load or pack them in housing (e.g. ferrites, cable harnesses with crimped contacts, electromechanical assemblies, large reels...)
- Screw holes in housings should either be left open and re-cleaned or ideally sealed immediately by inserting self-tapping screws in the blind hole (caution: in this case reworking should be restricted or prohibited).

## 2. Production processes

Optimisation strategies aimed at controlling particle sources should start from inside (processes, assemblies) and work outwards (immediate and general environment). In other words, look at events directly affecting the component first.

Prioritise processes according to the criterion which must be checked first and optimised if necessary. This gives the following sequence:

### Priority 1:

- Punching/bending processes
- Joining processes
- Screwing processes
- Soldering/welding processes
- Alignment
- Pincers
- Workpiece holders
- Packaging type (bulk goods)
- ...

These processes and tools should be designed for wear resistance and ease of cleaning. Unavoidable particles must

be removed from the product by passive means (particles fall off) or active (e.g. blowing and suction).

Particles must not be allowed to accumulate in the production area. These areas must be kept clean and inspected at regular intervals.

### Priority 2:

- Particles generated by system and tool wear
- Particle carry-over by personnel
- Particles from packaging
- ...

The active dispersal/discharge of particles by external operations such as maintenance work, open compressed air cleaning, angle grinding etc. should be avoided during production.

Draw up a code of conduct which defines the requirements (see clean zone definition in VDA 19 Part 2).

### Priority 3:

- Particles from the production environment (airborne particles that can travel large distances)
- Particles from the external environment (open windows, doors...)
- Particles thrown up by forklift trucks
- ...

## Environmental cleanliness and visualisation

Accurate answers and solutions can be found only by taking a product-related approach. This requires a specific analysis of internal production processes.

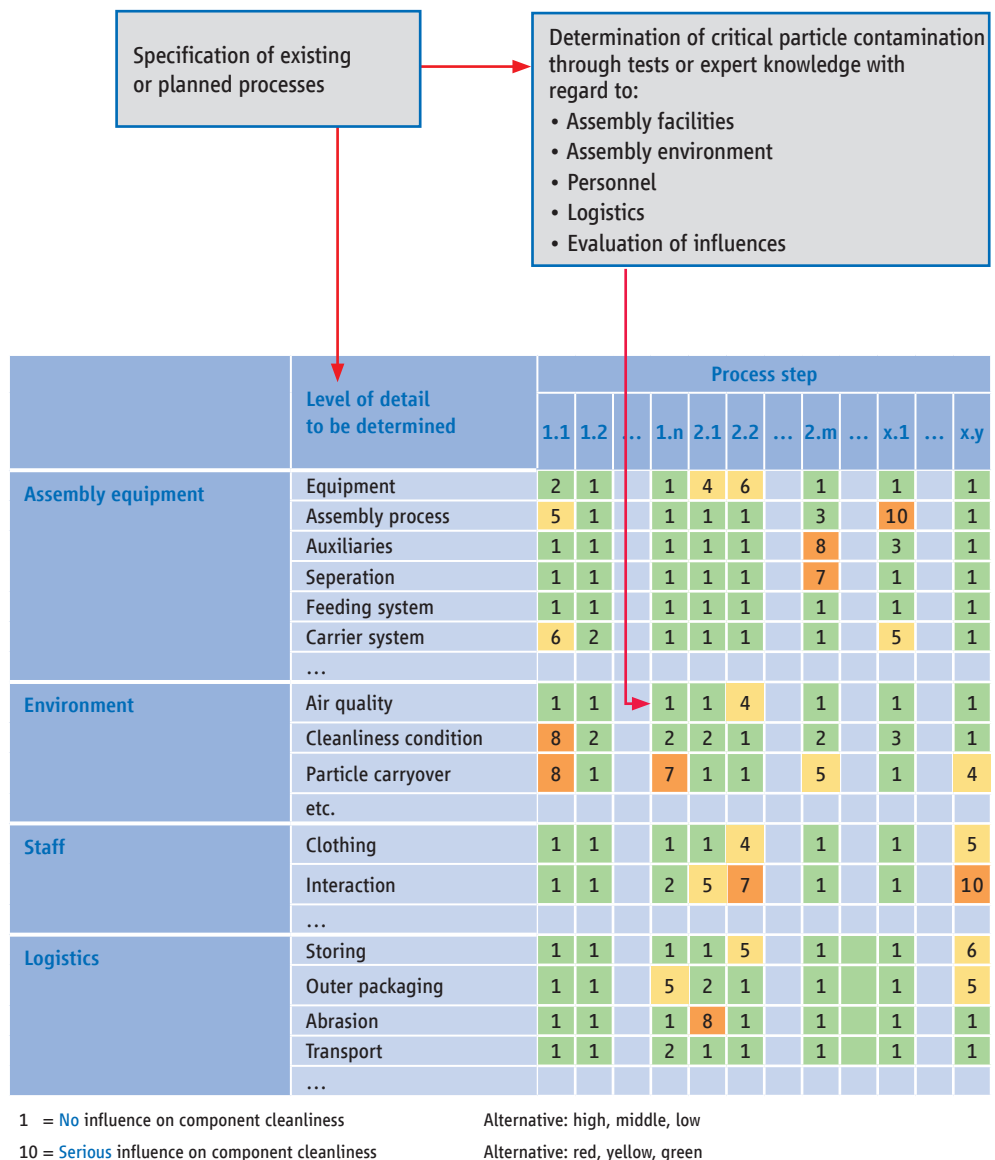
When preparing a tender specification (assembly machine), technical cleanliness must be dealt with as a special point. It is also advisable to draw up design rules specific to the product (error list with corrective measures) which define the following points, for example, in concrete terms:



- Processes should generate as few particles as possible or better still, reduce the number of particles present
- Process environments should be easy to clean
- Processes should remove particles from the component and from the operational environment
- Particles must not be allowed to accumulate
- Sensitive processes must be separated/partitioned to isolate them from processes that generate particles
- Workpiece holders must be designed to avoid generating particles:
- Minimum point supports
  - deburred and polished contact points/surfaces
  - 'soft' contact points/surfaces
- Workpiece holders must be designed to avoid particle accumulation
  - easy to clean
  - reduced surface area and open
- Gravity
  - preferred processing area 'underneath': particles drop down below the part
  - Particle generation and reduction in the vibrator feeder/oscillating conveyor

A process chain analysis as proposed in VDA 19 Part 2 gives structure to the process and provides an overview of the relevant particle sources:

Fig. 72: Process chain analysis as per VDA 19 Part 2



VDA 19-2 dedicates a whole chapter to ‘assembly equipment’, describing in detail the criteria and measures for different processes. It also includes an assessment of joining processes with examples.

## 4.5 Environmental cleanliness and visualisation

### Cleanroom production. Is it necessary?

Fig. 73, 74: Cleanroom production



#### Procedure for environmental analysis:

##### 1. Setting up and labelling particle traps

- If particle traps are to be used for comparisons, make sure they are installed at the same height.
- Label particle traps individually and systematically so that they can be assigned to the analysis reports.
- A photo illustrating the location of particle traps helps ensure reproducibility during reruns.

- Place a brief notice for employees with instructions such as “do not touch the adhesive pad” beside each trap.
- After removing the cover and protective film, mark the time of activation on the trap.
- After activation, make sure the cover of the particle trap is kept clean to avoid cross-contamination when it is replaced.

##### 2. Exposure time

- Inspect the adhesive pads regularly during the exposure period to check that they are not overloaded (see VDA 19 Part 1 Ch. 7.6).
- The usual exposure time is seven days. Cleaning operations undertaken in this period must be taken into account.

##### 3. Deactivating particle traps

- Replace the cover on the particle trap and ideally, secure it with adhesive tape.

##### 4. Analysis

- Analysis reports contain detailed information, such as the level of contamination on the particle traps.
- We strongly recommend the use of a clarification form with clear instructions on how to perform and record a particle trap analysis (see Appendix).

##### 5. Documentation

- A database can be used to automatically calculate the Illig values (see VDA 19 Part 2). The Illig value expresses the results of the analysis in a single numerical value.

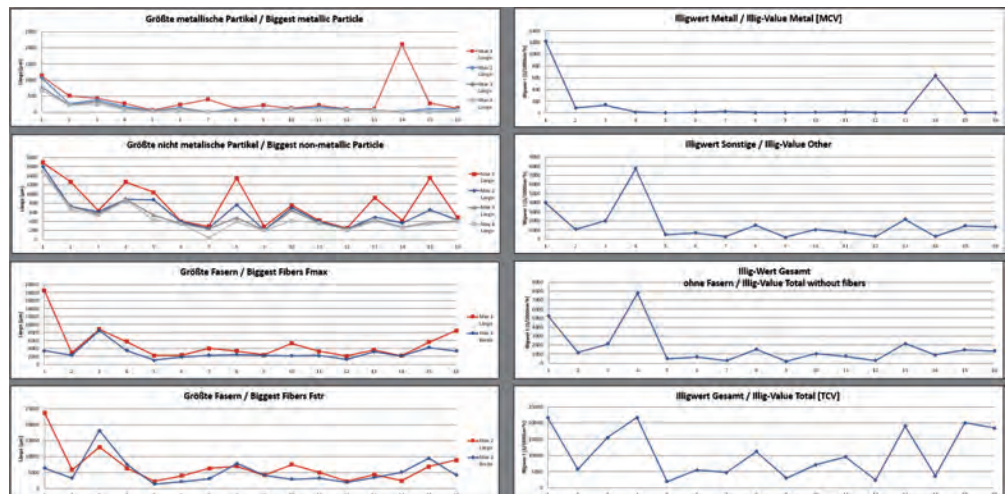
Fig. 75: Example particle trap



Fig. 76: Position of particle trap



Fig. 77: Database: Visualisation



## 6. Creating a database

Comprehensive data acquisition facilitates a systematic analysis of information. For this reason, it is worthwhile understanding the scope and scalability of the database. The aim is to capture data in as much detail as possible.

### Examples:

- Particle trap number, date and place of installation
- The three largest particles in each group (shiny metallic particles, other particles and fibres), length, and width if possible.
- Number of particles in each size class and particle type
- Exposure time and installation height
- Links to: analyses, photo of location and position in the production layout
- Important information such as 'insect in the trap', 'fingerprint' or 'significantly different height'

Diagrams generated automatically from selected values provide a visual snapshot of the degree of contamination of each production area.

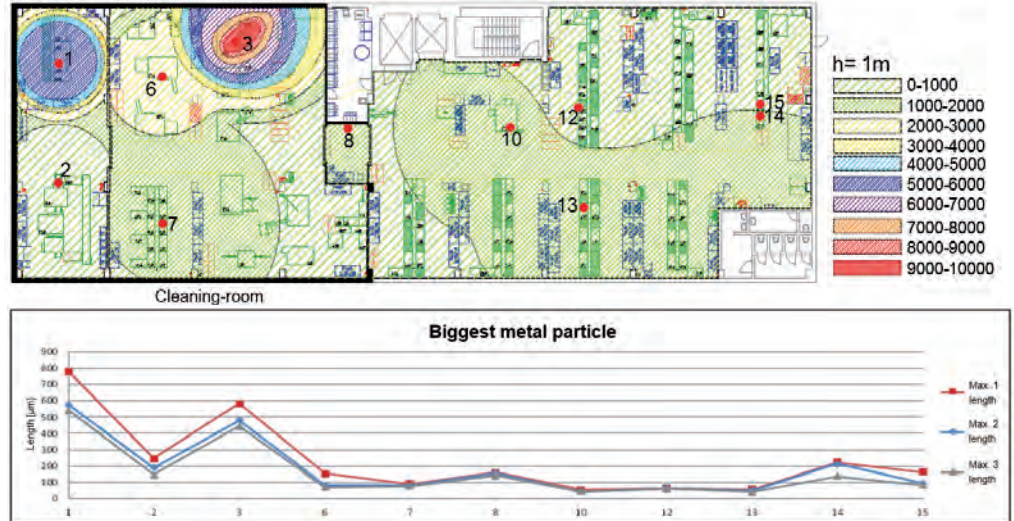
### Important information:

Since individual outliers tend to get lost if the Illig value is high, it is advisable to compare the length, and possibly width, of the three largest particles with the Illig value.

## 7. Visualisation of the Illig value in the production area

Fig. 78: Illustration of the Illig value with max. three particles

Metallic and non-metallic Illig value



It is important to:

- indicate the Illig value on the production layout, for example 'metal Illig value', 'metal + other Illig value' etc.
- include a key.

If changes are made in the production areas, for example the installation of a new ventilation system, evidence can be provided to show how the level of environmental contamination has changed.

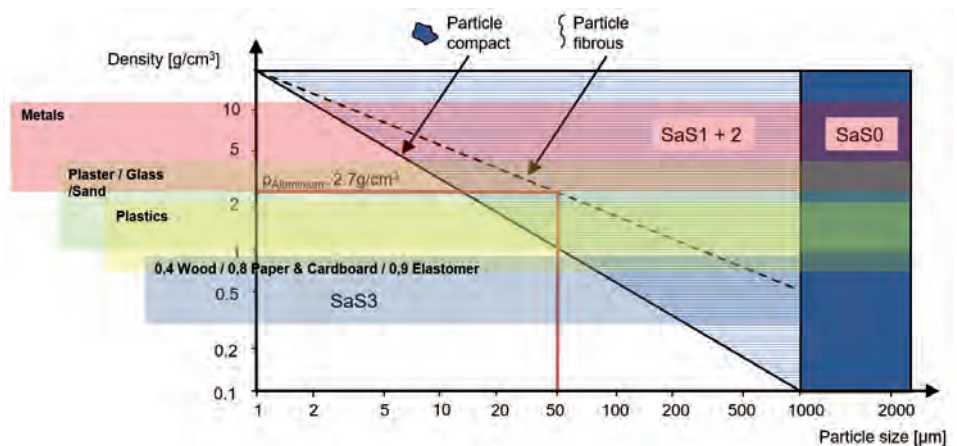
### Interpreting the results:

- Do ambient air particles cause critical contamination?
- In theory, the diagram showing the airborne dispersion of particles serves as the starting point.

The airborne dispersion diagram shows that metallic particles (worst-case scenario: fibre-shaped aluminium particle) of 50 µm or below can float in the air. This means that a clean room cannot effectively reduce the number of larger metallic particles.

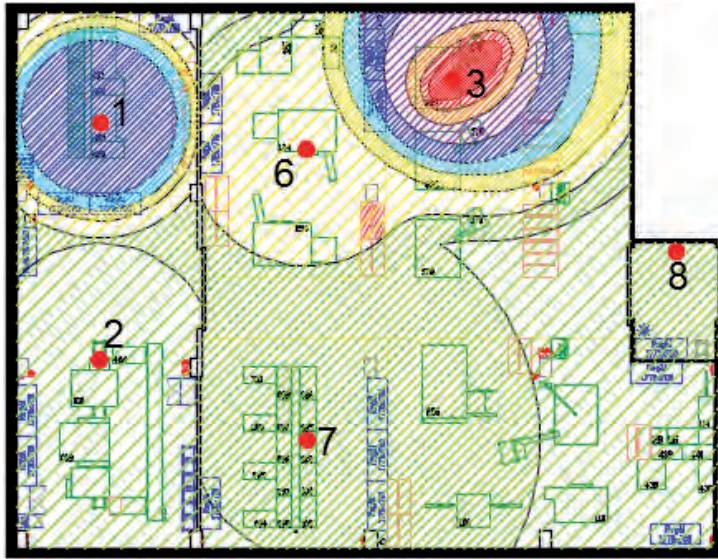
Codes of conduct must be drawn up for the implementation of cleanliness-controlled areas. VDA 19 Part 2 makes a wide range of suggestions which can be applied to individual configurations.

Fig. 79: Airborne dispersion diagram





**Fig. 80: Analysis results in the cleanroom:**



The analysis results show that some particle traps (shown in red) in the cleanroom are significantly more contaminated than others. These are also significantly worse than the results from the area not governed by VDA 19.

**Fig. 81: Analysis results in the area not governed by VDA 19:**



This is due to the chosen locations of the particle traps. Particle traps 2, 6, 7, 10, 12, 13, 14 and 15 were placed away from the manufacturing processes to collect particles from the ambient air environment<sup>1</sup>.

Particle traps 1 and 3 were placed within the processing area and have recorded the process environment<sup>2</sup> in addition to the ambient air environment.

**The following conclusions can be drawn from the analysis performed:**

Environmental cleanliness generally has a limited influence on component cleanliness. Production processes (internal/external) usually have a significant influence on component cleanliness.

The use of particle traps is an appropriate means of monitoring cleanliness. This method provides an opportunity to focus monitoring efforts on the ambient air environment or the

process environment. This should be specified in advance.

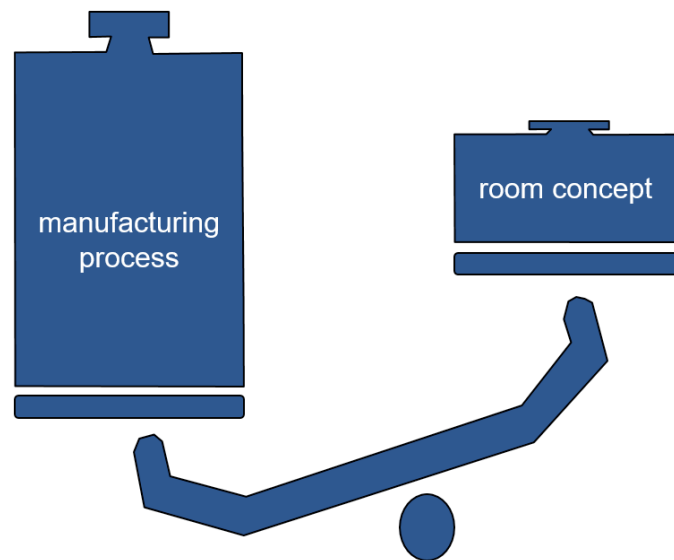
When choosing suitable locations for particle traps in the process environment, consideration should be given to the particle trajectory.

Unlike the 5S method, in this case the main concern is to obtain information about product contamination.

<sup>1</sup> Ambient air environment: Air quality without the influence of manufacturing processes

<sup>2</sup> Process environment: Air quality with the influence of manufacturing processes

Fig. 82: Weighting of factors influencing technical cleanliness



#### Conclusion:

**Manufacturing processes** (internal/external) must be compatible with cleanliness control!

This statement is supported by accredited laboratories.

#### 4.6 Cleaning tips

A clean workstation is essential to ensure technical cleanliness standards are met. Any particles produced at a workstation should ideally be removed immediately. Screen-type (fly screen) work surfaces, for example, facilitate separation at no additional costs. Use suction-cleaning to promptly remove large quantities. Particle contamination caused by hands or work clothes is particularly problematic when employees frequently change activities. In this case, measures such as airlocks, hand-washing and gown-changing are advisable.

#### 4.6.1 Washing

Parts washers are cleaning systems for components; however, they have not been introduced as a standardised industry-wide procedure. Due to costs, technical compatibility (e.g. corrosion, deformation) and in some cases, poor efficiency, washing processes are primarily used for critical applications (aerospace industry) or in the event of special contamination. For instance, they are widely used for removing oil, grease or flux residue (ionic contamination) rather than particulate contamination.

#### The electronics and metal sector account for the majority of applications.

Efficient filtering is required to extract the particles from the cleaning liquid. With wet cleaning, for instance, there is a risk that dirt particles will be washed up into 'dead zones' and cavities or that the oil film or conductive salts will be distributed across the entire surface.

A distinction is always made between solvent-based and water-based cleaning processes. Water-based cleaning requires the use of some additives, e.g. corrosion inhibitors. Selecting the medium, controlling the cleaning effect and maintaining the baths is also more labor-intensive.

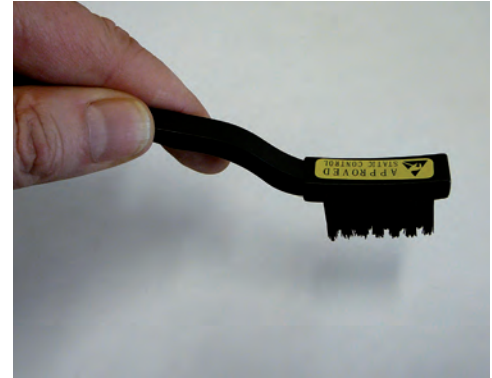
#### 4.6.2 Brushing

Brushes remove more firmly adhering particles from the surface. However, particles may accumulate in the brush, which must be cleaned regularly or replaced. Since the relative motion of insulators generates static electricity, it is advisable to use an ESD brush to ensure discharging via the hand and person to the ground. When using ESD brushes with conductive carbon fibres it is important to remember that these fibres might break and form a potential source of conductive particles. It could be argued that particles that have not fallen off after brushing have good, persistent adhering properties and are thus uncritical. Manual brushing always poses a risk as to how carefully it is executed by the operator. The frequently complex geometry of components and low system flexibility are not suited to automated processes.

**Fig. 83: Manual cleaning with brush and illuminated magnifier**



**Fig. 84: ESD brush**



#### 4.6.3 Suction-cleaning

Suction-cleaning is always a good option since particles can be removed from the process in a targeted manner. One disadvantage is its low penetration depth and the limited vacuum or suction that can be created. Unfortunately, suction processes frequently involve increased noise exposure.

#### 4.6.4 Blowing

Blowing is another alternative which uses an air flow to clean the surface. This quick process is also effective at greater penetration depths.

Compressed air is commonly used on the shopfloor. Make sure it is oil-free. Ionised air is typically used for blowing processes.

However, improper implementation may result in particle spread, e.g. to adjacent components or into the environment where it may endanger the operator's health (eyes, dust inhalation).

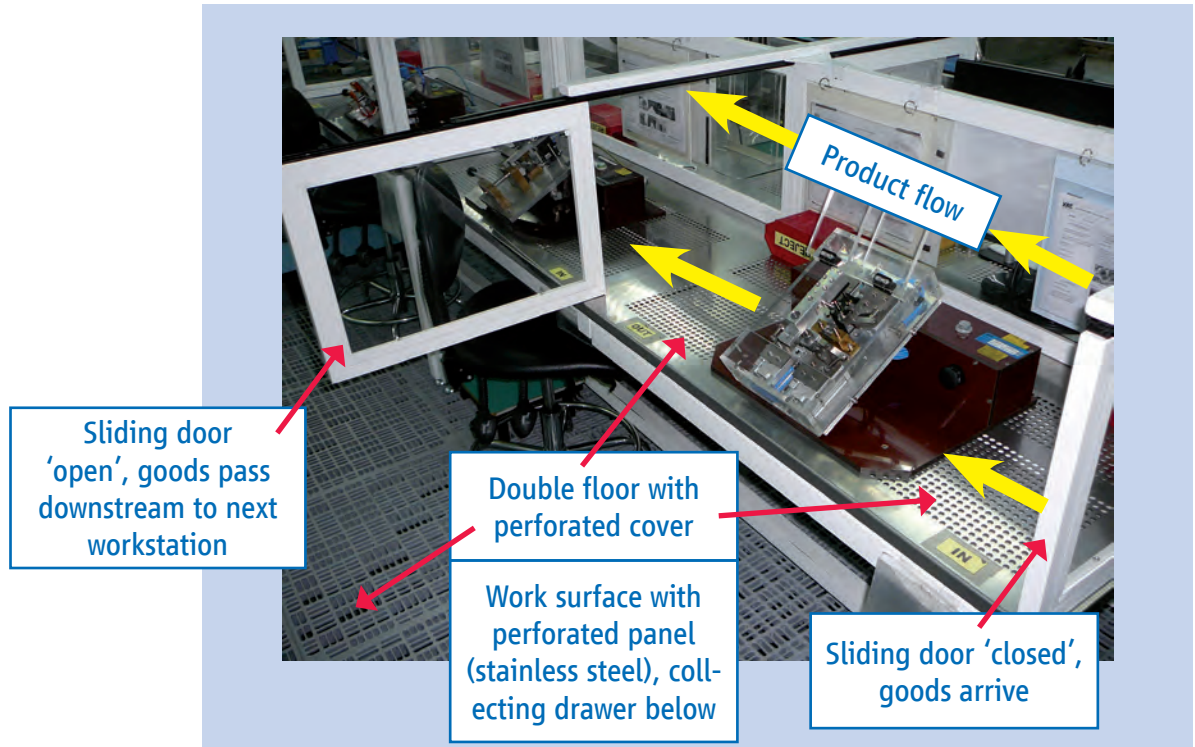
The smaller the metallic particles, the better they adhere to other surfaces due to electrostatic forces. In this case, simply blowing off the particles is not sufficient; mechanical action such as brushing will be more successful.

A combination of blowing and brushing is widely used in practice.



#### 4.6.5 Reducing carry-over and controlling cleanliness in workplace design

Fig. 85: Workstations designed for cleanliness control



The perforated system on the worksurface and floor ensure that particles are removed from the workspace with no additional effort or expense. Sliding doors between workstations provide 'particle-tight' barriers which are opened only to transfer products downstream. This setup limits particle carry-over and significantly reduces the amount of particles on the products.

Workstations like these designed for cleanliness control can be integrated into existing production areas and thus represent an affordable modular option for improving the particle count on products in the production line. This solution deals with particles generated by the process which drop down by gravity due to their size and weight.

#### 4.6.6 Adhesive methods

Adhesive methods such as rolling and stamping can be used to clean flat surfaces, e.g. PCBs.

Fig. 86: Adhesive roller system for PCB contact cleaning



## **4.7 Packaging and logistics requirements**

- Packaging material that is in direct contact with the component must meet the same cleanliness requirements as the component and effectively protect the component from external contamination which could impair functioning.
- The packaging must ensure that no additional particles or other contaminants are generated which could impair functioning.
- It must also prevent the recontamination of components during removal from the packaging, storage or further processing.
- Within the process chain, cost-effectiveness and efficiency must be optimised to ensure that levels of cleanliness are maintained wherever possible.

# 5 Why do metallic particles in assemblies so rarely cause short circuits?

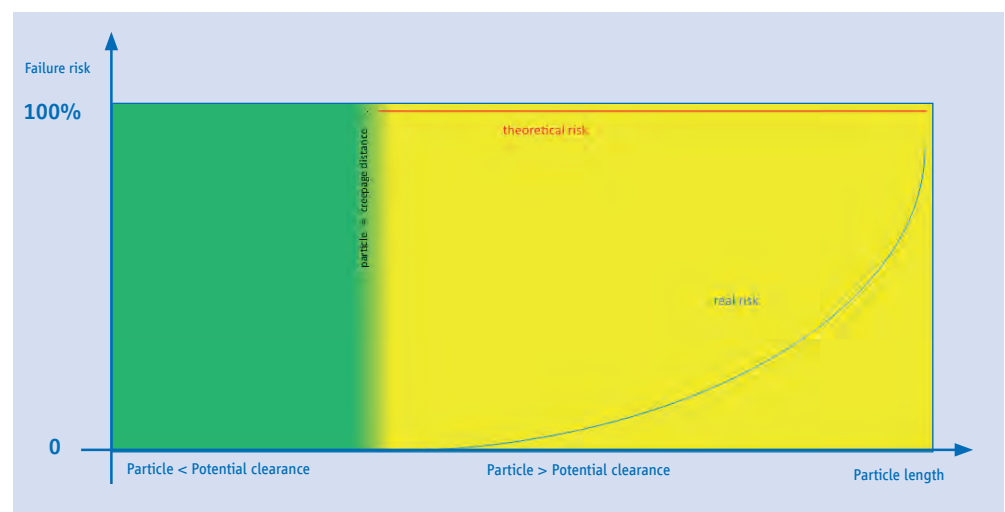
When we look at failure events in housed assemblies in the automotive industry, for example, and analyse the most critical group – metallic particles – in relation to an electrical short circuit, the findings do not match the amount of metallic particles found in the extraction analyses.

This discrepancy can be graphically illustrated as a gap between the theoretical and actual field risk. It is generally assumed that the risk of an electrical short circuit caused by metallic particles rises sharply if the particle length is the same size or larger than the smallest electrical clearance between two current-carrying (live) areas. Investigations conducted by the ZVEI working group have shown that in reality the function is significantly flatter than one would expect from a purely theoretical analysis based on geometry. The volume of particles and their mobility during the operation of an assembly in the field largely determine the shape of the function.

The theories and assumptions listed below have been proposed to explain this discrepancy, and will be considered in more detail in the following chapters:

- Not all geometric short circuits are electrical short circuits (probability of short circuit).
- Liquid particle extraction indicates more “mobile” particles than are actually mobile under operating conditions.
- During operation, mobile particles get permanently stuck in areas (particle sinks), thus rendering them immobile.
- Not every pair of adjacent contacts that is short-circuited by a metallic particle causes a problem or malfunction (“short circuits without consequences”). The probability of a short circuit decreases with the age of the contact elements (particle and electronics) due to increasing oxidation and accumulated layers of contamination.

Fig. 87: Diagram showing failure risks based on metallic particles on assemblies



## 5.1 Probability of contact

### 5.1.1 Introduction and theory

An electrical contact is created when two current-carrying parts connect (Lit. 1). A short circuit caused by a conductive particle between two potentials in an electronic system thus creates two contacts. The assumption that a conductive particle which geometrically connects two conductors, contact points or similar inevitably creates an electrical bypass does not take account of all the physical circumstances. A theoretical deduction of the probability of contact is possible only to a limited extent, since not all influencing factors and their parameters can be fully measured and investigated.

#### Influencing factors:

- contact normal force
- surface topography
- surface oxidation
- duration of contact
- electrical conductivities
- voltage difference
- films and other layers of contamination

When two contact surfaces touch one another, only very small areas actually make contact due to surface roughness. These areas are referred to as the effective contact surface. The transfer resistance and accomplishment of the electrical contact is determined by the situation at these local contact points.

Furthermore, in everyday situations layers of contamination can be found on the metal surface (Lit. 2).

1. These layers of contamination may simply be composed of gas molecules that are deposited on the surface due to Van-der-Waals forces, which are based on electrical phenomena (physisorption).
2. After a certain time, the gas molecules begin to disassociate, for example due to the catalytic effect of the base metal, releasing gas atoms which bond more strongly with the metal (chemisorption).
3. Depending on the metal and the gas, metal ions can escape from the metal matrix and chemically react with the base metal and the chemisorbed gas atoms. Metal oxides or, in the case of silver and sulphur, sulphide layers are deposited on the surface as reaction products.
4. This layer of contamination continues to grow as additional metal ions and gas atoms migrate into it over time.

Not all metals follow these four stages in full (Lit. 3).

The gold-oxygen system merely saturates the metal surface with gas ions, while the oxidation that occurs with platinum-oxygen has a passivating effect, thereby limiting further growth of the contamination layer.

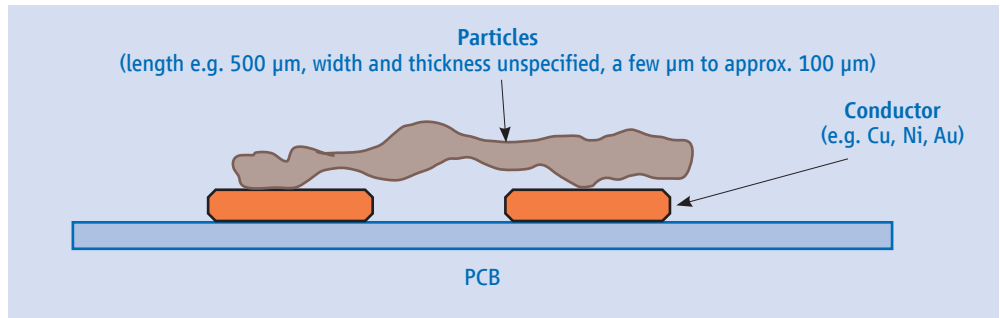
Given sufficient voltage, the gas layer formed in 1 and 2 offers no resistance to the flow of current since the tunnel effect enables electrons to tunnel through it loss-free. The layers of contamination formed in 3 and 4 significantly hinder the flow of current, resulting in total insulation in certain circumstances.

Lit. 1 VDE 0660/12.52

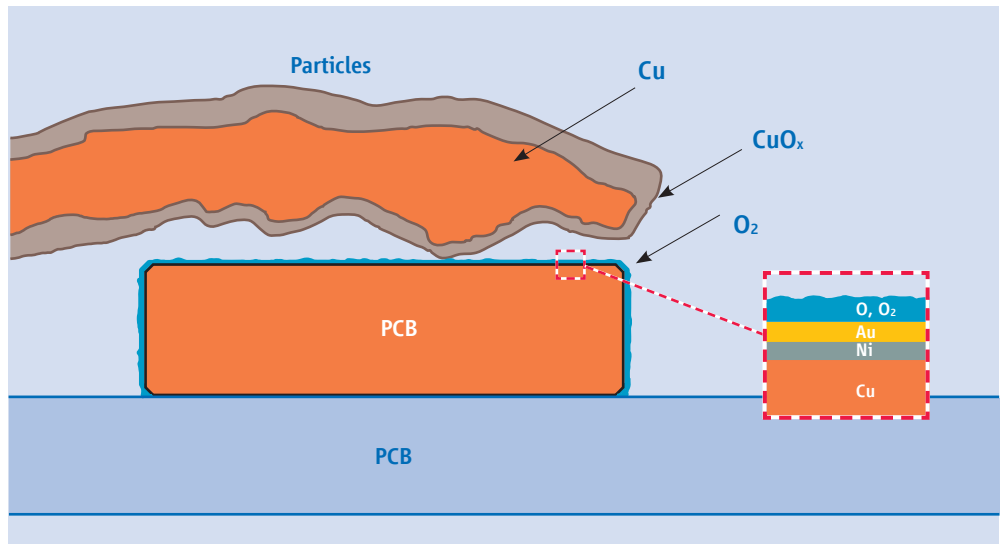
Lit. 2 Vinaricky, Elektrische Kontakte, Werkstoffe und Anwendungen, Springer Verlag, 2002, p. 413

Lit. 3 Keil, Werkstoffe für elektrische Kontakte, Springer Verlag, 1960, p. 23

**Fig. 88: Sketch of electrical arrangement (particle forming “bridge” between two conductors)**



**Fig. 89: Diagram showing contact point of a particle on a conductor: nickel-gold conductor and copper particle (zoom image of Fig. 83, sketch of principle, not to scale)**



The layers of contamination vary in thickness and hardness and correspondingly differ in terms of electrical breakdown. Gold, for example, produces an adsorbed gas layer of only approx. 1–10 nm which can be easily tunneled through and thus presents no barrier. Tin, which is an essential material in electrical engineering, has a passivating oxide layer of approx. 50–100 nm which is extremely hard and can only be penetrated by friction or plastic deformation (Lit.2, p. 413). The copper oxides forming on copper are semiconductors which, with an ideal stoichiometric composition of 10 GΩ cm, have high impedance, but can easily achieve resis-

tances in the kilo Ω range if their stoichiometric composition deviates from the ideal (Lit. 2, p. 36).

A fresh metal surface produces layers of oxygen which are absorbed at different speeds depending on the metal. While copper was found to produce a few layers after 20 seconds and up to ten layers after ten minutes to several weeks, with gold only one layer was found after ten minutes and still only one layer was recorded after two days. Aluminium exhibits extreme behaviour in this context, producing seven layers after just 20 seconds (Lit. 4).

Lit. 2 Vinaricky, Elektrische Kontakte, Werkstoffe und Anwendungen, Springer Verlag, 2002, S. 36, 413  
 Lit. 4 Holm 1967, S. 106

Correlations between contact force and contact resistance are known to exist from studies into switching contacts such as relays. However, it is doubtful whether these apply to the problem described here (a metallic particle lying between two contact surfaces, both sides of which may be contaminated). Studies in the literature (Lit. 4, p. 49) are based on minimal forces of  $0.5 \times 10^{-5}$  N, whereas a cylindrical copper particle with dimensions  $d = 50 \mu\text{m}$ ,  $l = 600 \mu\text{m}$  has a contact force of only  $5.2 \times 10^{-8}$  N on one side of the bridge. This type of small contact force produces only elastic deformations on the metal surface. In addition to these phenomena which can be found on contact surfaces under labora-

tory conditions, the supposed protective, or rather contaminating, effects encountered in everyday life must also be considered, such as accumulations of dust, non-conductive particles, organic substances etc. on the contacts.

All these deposits insulate to a greater or lesser extent and when pressure is applied can be penetrated fully or, at the other extreme, not at all. In other words, they are additional variables in terms of actual behaviour.

### 5.1.2 Testing the probability of contact

Prior to assessing the probability of contact of metallic particles under realistic environmental conditions, experiments were conducted to examine more closely the short circuit risk. This was done by simulating one of the most likely short circuit situations in an electric circuit: A particle moves around on an installed electronic assembly and lands on two metallic contacts.

#### Test setup:

Representative metallic components used in electrical engineering were assembled. The selection was based partly on their use in typical electronic circuits and also on those materials which were found as particles in extraction analyses.

Table 28: List of materials used in the test

	1	Cu	Copper	e.g. cables, power rails
	2	CuNiSi	Copper alloy	e.g. contact material, press-in pins
	3	Au	Gold	e.g. bonding wire, connector coating
	4	Sn	Pure tin	e.g. coatings
	5	SnAg3Cu0.5 (SAC305)	Solder material	e.g. solder paste, solder bars
	6	ZnAl4Cu1	Zinc alloy for die-casting	e.g. housings
	7	AlSi12	Aluminium alloy for die-casting	e.g. housings, covers, holders
	8	CuFe2P	Copper-iron	e.g. bus bars, lead frames
	9	FeSi3	Electrical steel	e.g. stators, rotors, transformers
	10	X10CrNi18-8	Spring steel	e.g. springs
	11	MnZn-Oxid	Ferrite	e.g. magnetic core, chokes, transformers

Lit. 4 Holm 1967, p. 49



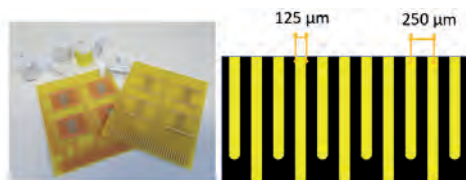
To obtain realistically shaped particles, the materials were filed to produce particles of 500-600  $\mu\text{m}$ . The bonding wire was cut.

The following particle conditions were considered when determining the probability of short circuit:

- New condition (particle produced immediately before measurement)
- Ageing in a dry climate (155°C; 4h; as per IEC 60068-2-58)
- Ageing in a humid climate (85°C; 85% RH; 4h; as per IEC 60068-2-58)

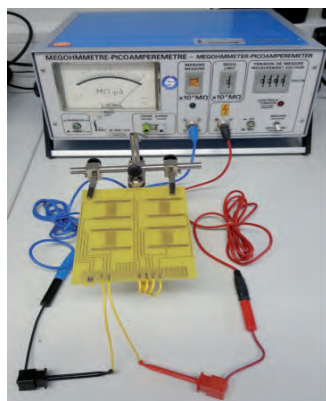
Test circuit boards with a comb structure were produced as counterparts. In the first case, the conductive structures consisted of fresh conductors (NiAu) and in the second case soldered conductor surfaces after a reflow process with SAC 305. The circuit boards had no solder mask in the gaps which might otherwise impede contact of the particles.

**Fig. 90: SIR test circuit boards (interleaving comb pattern layout)**



The measurements were performed with different configurations.

**Fig. 91: Voltage source which measures current with an analogue picoammeter**



**Fig. 92: Automated current measurement with software**



#### Test performance:

A particle was manually placed on top of two adjacent conductors in such a way that it could be assumed from a visual inspection that it was resting on both metal surfaces. Then, the DC voltage between the conductors was increased from a starting point of 1 V to maximum 60 V in increments of 1 V, with each voltage value sustained for approx. five seconds. When a significant current flow was recorded, the voltage applied at the time was noted as the measurement result, i.e. as the breakdown or frittage voltage. The current of the voltage source was restricted to maximum 2 mA. After repositioning the particle, the measurements were repeated. To obtain a statistically relevant basis, this process was repeated until 25 breakdowns were achieved. Together with the number of measurements for which no breakdown occurred when 60 V was applied, this gives the 100 percent cover. Since the effort required to achieve 25 breakdowns was too high in some cases, the maximum number of measurements was limited to 50. This meant that at least 25 and maximum 50 measurements were performed for each particle and position.



Particles were frequently observed to adhere slightly to the circuit board after breakdown. The micro-fusion of the metallic particles to the conductors of the circuit board observed in the tests indicate "fritting". This behaviour describes the electrothermal breakdown process whereby a layer of contamination suddenly reduces the resistance of megaohms in the ohm range as voltage increases. The semi-conducting layers and field behaviour are largely responsible for this. After the breakdown, metallic bridges form between the contact elements (Lit. 2, p. 38ff).

### 5.1.3 Results

The measurement results for copper particles on soldered PCBs are presented here in the form of a bar chart.

The probability of contact in relation to the different voltage ranges was calculated cumulatively as follows:

$$\text{Probability of contact} = \frac{\text{Number of breakdowns} \times 100 \%}{\text{Number of all measurements}}$$

A comparison of all the results shows how applied voltage, particle condition and material influence the contact characteristics.

Some measurement results show significant variation, but they were based on realistic simulations and therefore reflect the complexity of the circumstances. However, some of the variation can probably be attributed to the fact that the tiny particle dimensions made the test performance particularly challenging.

Fig. 93: Comparison of Cu particles in three conditions on SAC305 PCBs

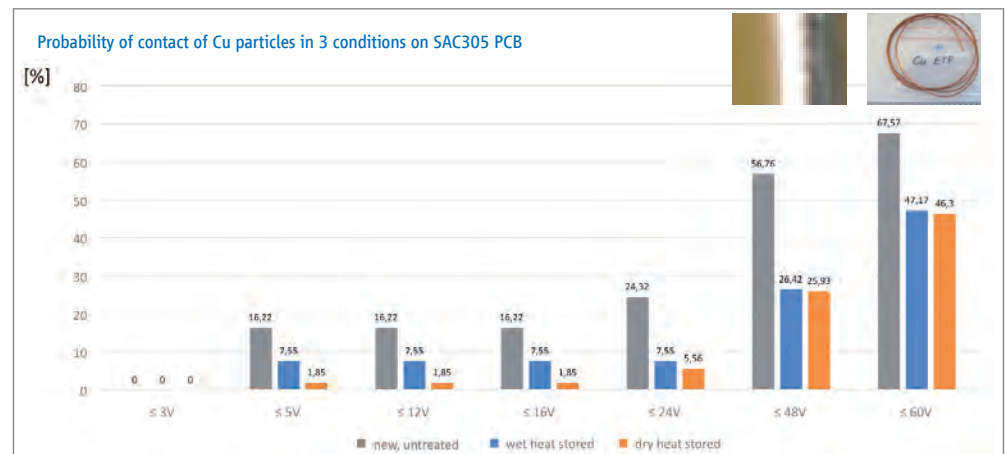
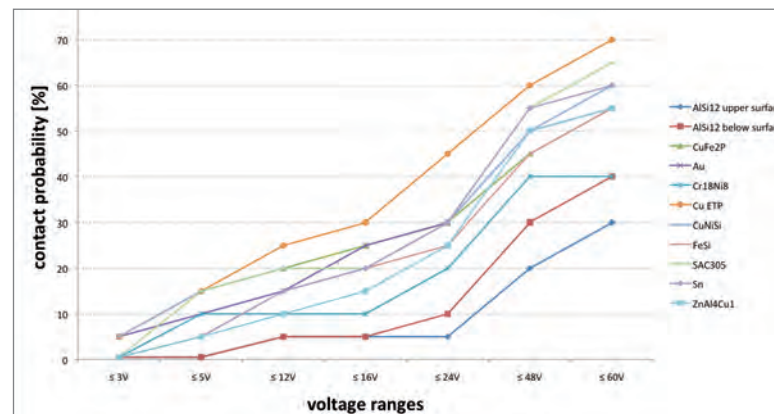


Fig. 94: Overview of all metals in the voltage classes, rounded



The results can be summed up as follows:

- The probability of electrical contact based on all the combinations tested is significantly below 100 percent.
- The probability of short circuit varies depending on the materials, but the consistent underlying trend is that probability increases in line with increasing voltage.
- The probability of short circuit is very low for low voltages, but often increases significantly above 12 V. These significant differences should be considered with regard to standard 12 V applications and modern 48 V applications.
- Storage under aggravated climatic conditions such as dry heat or moisture reduces the probability, which suggests a surface reaction of the metals – for example the formation of metal oxides.
- The probability of short-circuit tends to be higher with precious metals such as gold than with base metals like aluminium, for example.

## 5.2 Rinsing extraction versus actual mobility

The cold-cleaning processes performed as part of a cleanliness analysis can detach significantly more particles than would realistically be possible during field operation, for example when exposed to vibrational forces in the vehicle.

This can be demonstrated in two ways:

1. In accordance with VDA 19, it is permissible to perform the cleanliness analysis by air extraction in addition to liquid extraction. Comparison of both extraction methods shows that the particle count tends to be lower with air extraction.
2. Vibrational forces acting on a product during operation in the field have been simulated in a simplified manner in laboratory tests:

- a. In a random test, ten powerful impacts (approx. 2 Joule) were consecutively applied to a vertically suspended assembly. After each impact, the particles that had fallen from the circuit board were quantified. When all ten impacts had been applied, the circuit board underwent a cleanliness analysis with cold cleaners. The ten impacts were found to have dislodged only 30 to 50 percent of the particles. The remaining 50 to 70 percent of the particles could only be removed by the cleanliness analysis with cold cleaners.
- b. In a further test, a PCB was placed on a vibration table and exposed to a typical automotive vibration profile. The particles detached by the vibration test were quantified. Then the circuit board underwent a cleanliness analysis with cold cleaners. Only approx. six percent of the particles were detached by the vibration profile. The remaining 94 percent of the particles could only be removed by the subsequent cleanliness analysis with cold cleaners.

## 5.3 Particle sinks

Particles which find themselves on an electrical assembly are held there by various mechanisms; but this does not remain the case for all particles. The adhesive forces generated by Van-der-Waals forces, electrostatic or magnetic forces, for example, are influenced to some extent by material and particle size. Every vibration or impact may detach some particles; the mounting position plays a major role in this process. In a vertical mounting position, a significant proportion of particles will detach and fall down due to gravity. In this case, the floor of the housing acts as a sink. The detached particles collect here and further vibrations are unlikely to propel them back on to the assembly. In a horizontal mounting position, particles can roam around the assembly for longer, surviving many

impacts and therefore remain active. Experience shows that many particles gather in a corner after more impacts, get trapped or, on reaching the edge of the assembly, drop down and are permanently ejected.

The smaller the particle, the higher the adhesive force in relation to the gravitational force. In terms of impacts, this means that the particle's mobility declines significantly as its size increases.

## 5.4 Effect of short circuits on ICs

Due to specific pin assignments, it is not possible to take a universal approach to examining the effects of short circuits on ICs. Nevertheless, some basic pointers are given below. In ICs, voltages of 3-5 V are normally applied between the individual component pins. This is significantly below the current market standard for ISO on-board power supplies of 12 V in vehicles, and thus correspondingly reduces the probability of contact (see Chapter 5.1).

It is also important to evaluate the extent to which electrical short circuits between certain potentials can be intercepted by the software used.

Ultimately, only a limited number of adjacent pins can result in functional failure. A Pin FMEA can be used to identify these pins and analyse the functional failures.

## 5.5 Tool for estimating the risk of short circuit (<https://bauteilsauberkeit.zvei.org/>)

### 5.5.1 Introduction

Component specifications often include particle limits based on the smallest electrical clearance between two current-carrying areas. This has given rise to extremely strict requirements which are impossible to implement from either a technical or commercial point of view and furthermore, are unnecessary given the risk of an electrical short circuit occurring on the assembly.

Let's take an actual assembly as an example; a single circuit board contains hundreds of components. Often only a small number of these are fine-pitch components (pitch 0.4/0.5 mm). Many other components have a pitch clearance of more than 1 mm. If the limits for tolerable metallic particles were derived on the basis of fine-pitch components, maximum permissible particle lengths would be in the 200 µm range (allowing for solder pads).

We can explore the usefulness of specifying such strict limits by performing the following thought experiment: According to the above-mentioned approach, the following would apply:

Metallic particles on the PCB with a length of 199 µm pose no threat; but with a length of 201 µm there is a potential risk of an electric short-circuit, although not a 100% risk (failure of all assemblies due to the presence of only one particle with a length of 201 µm).

To make a knowledge-based assessment of this extreme difference between zero and 100 percent, we have devised a sample application-specific risk assessment based on the electrical short circuit presented below. This approach takes into account the actual situation with regard to all clearances between current-carrying areas as well as the actual particle load on the product being assessed.

It enables us to deduce a probability of failure linked to different application-specific boundary conditions.

This is based on the assumption that an electric short circuit equates to a functional failure of the assembly. This would certainly not always be the case in reality.

About 1: Obviously, a particle extends in width and height in addition to length. But actual particles do not have a flat surface; in reality their topological features create individual points of contact. So to take a line instead of individual points as the starting point is already a worst-case scenario.

About 2: With regard to electrical clearances between two current-carrying areas, in reality

**Fig. 95: Functional structure of risk assessment tool**



### 5.5.2 Model hypotheses

The model design is based on the following hypotheses and simplifications:

1. A particle has a negligible width
2. The conductors under consideration are located on different potentials
3. The particles present are evenly distributed in the assembly
4. The particles have geometrically "perfect" contact surfaces, i.e.:
  - a. a flat surface across their entire length
  - b. no curvature
5. Each geometric contact also results in an electrical contact
6. Particles are mobile
7. A uniform voltage is applied to the entire assembly

some of these are on the same potential. The chosen hypothesis assumes that all current-carrying areas have different potential and thus also represents a worst-case scenario.

About 3: As a general rule, particles can be evenly distributed throughout the assembly. In practice however, particles are influenced by gravitational and adhesive forces and therefore accumulate locally. The "equal distribution" hypothesis may or may not be conservative, depending on whether the particle accumulations are close to adjacent, critical, current-carrying areas.

About 4: Curved particles would not necessarily come into contact with both contact surfaces if solder mask, for example, was between the current-carrying areas. Thus the "no curvature" hypothesis is also a worst-case scenario.

About 5: In practice, not every geometric contact results in an electrical contact. This depends on several boundary conditions, see Chapter 5.1, so this is also a worst-case scenario.

About 6: Particle mobility is an essential requirement if particles are to pose a risk during field operation in addition to the initial risk detected during the end-of-line test. The calculation tool makes the worst-case assumption that each particle under consideration is not adherent and thus mobile.

About 7: The voltage applied to the entire assembly (normally ISO on-board power supply of 12 V) is used in the model rather than the voltage actually applied between the individual pins of fine-pitch components – this assumption also constitutes a worst-case scenario.

### 5.5.3 Calculation methods

According to the basic principles outlined in Chapter 5.1.1 and the model hypotheses made in Chapter 5.1.2, the risk of an electrical short circuit posed by particles in one size class can be calculated using the formula below.

$$P_{failure} = \frac{A_{critical}}{A_{total}} * n * O_{particle} * GF_{contact} * GF_{PCBor} * GF_{PrSp} * GF_{mobile}$$

The calculation tool adds together the risk posed by particles in their clearance class and the risk posed by these particles in all smaller clearance classes. This is added up across all particle size classes.

- $P_{failure}$  Probability of failure  $0 \leq P \leq 1$
- $A_{critical}$  Critical area (see next chapter) of the size class under consideration
- $A_{total}$  Total area accessible to particle
- $n$  particle count for size class under consideration (e.g. results from extraction analysis of a component)
- $O_{particle}$  Particle orientation factor (see Chapter 5.5.4)
- $GF_{contact}$  Probability of contact for geometric connection is determined from particle material, voltages and ageing (see Chapter 5.1)
- $GF_{PCBor}$  PCB orientation = installation environment of PCB (1 ... horizontal, 0.01 ... vertical, 0 ... overhead, with the cosine of the installation angle in between)
- $GF_{PrSp}$  Product-specific factor due to heat-conductive pastes, adhesives, magnetic fields etc.
- $GF_{mobile}$  Factor for actual mobile particles vs. particles recorded by liquid extraction (see Chapter 5.2)

Detailed information about the different factors can be found in the following sections.

### 5.5.4 Orientation factor

In practice, contact surfaces often run parallel, for example component pins, conductors or similar

If we look at a diagram of this type of contact pair (see Fig. 96) with clearance D, it is clear that the length, angle and position of a particle on the critical area (shown in pale blue) must be “correct” to achieve geometric contact.

This complex issue can be described mathematically using the solution to Buffon’s needle problem.

There are three possible options:

#### 1. Particle length L < clearance D

There is no geometric contact and consequently, no electrical contact.

### 2. Particle length $L = \text{clearance } D$

Geometric contact is possible if the particle is oriented perpendicular and centred in relation to the contact pair ( $\alpha = 0$ ,  $m = D/2$ ).

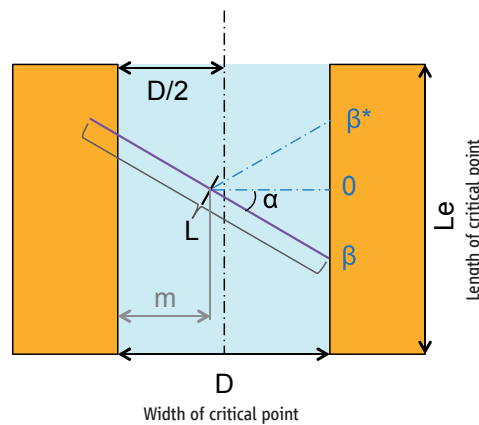
Electrical contact is possible if the boundary conditions described in Chapter 5.1 are met.

### 3. Particle length $L > \text{clearance } D$

Geometrical contact is possible even if the particle is rotated ( $\alpha \neq 0$ ). The number of opportunities to make contact increases as a function of particle length.

As particle length  $L$  increases, so too does the probability of geometric contact, since the particle can also be displaced laterally by  $m$  and still maintain geometric contact.

**Fig. 96: Geometric constraints at a contact pair**



### 5.5.5 Critical area

On circuit boards there are various metallic contact surfaces that are not covered with solder mask such as component pins, lands and vias. The areas in between (shown in green in Fig. 97–99) correspond to the critical areas in Chapter xx. The type and size depend on the clearance class under investigation. We then try to classify these areas in a meaningful way, in the simplest case using the size classes (clearance class here) defined in VDA 19 / ISO 16232. This approach is illustrated in figure

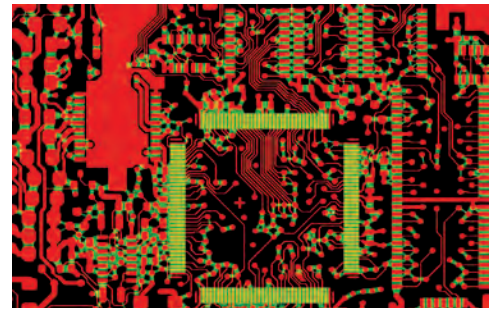
**Fig. 97: Clearance areas up to  $400 \mu\text{m}$  (in green)**



**Fig. 98: Clearance areas up to  $600 \mu\text{m}$  (in green)**



**Fig. 99: Clearance areas up to  $1000 \mu\text{m}$  (in green)**



It is clear that small clearance classes (e.g. fine-pitch components) are somewhat under-represented and that as the clearance class increases, so does the area fraction.



### 5.5.6 Number of particles per size class

The particle load on the product being tested serves as a further input variable for calculating the probability of failure. Since the error pattern being investigated is the electrical short circuit, only metallic particles are of interest in this respect. To be transferred to the calculation tool 1:1 for inclusion in the calculation of failure probability, these metallic particles should be classified according to the size classes defined in VDA 19 Part 1. Note that the values for individual particles within a size class may of course fall anywhere between the upper and lower size limit. In this basic configuration, the tool calculates conservatively using the maximum value. However, this may be adjusted by the user.

The input values can be extracted either as actual values from the cleanliness analyses or as target values from existing specifications.

Actual values give typical failure rates for the error pattern "electrical short circuit" as snapshots, whereas target values give an upper limit permitted in the supply chain as per specification.

In addition to the abovementioned use for quality assurance purposes, the calculation tool can also be used in development to determine particle limits for a given failure rate (e.g. defined by the customer).

### 5.5.7 Weighting factors

As well as the measurable and calculable factors, other physical variants (weighting factors) also influence the probability of failure.

The following relevant factors were investigated:

1. Mounting position
2. Probability of contact
3. Results of the cleanliness analysis compared with actual mobile particles
4. Product-specific factors

About 1: According to the model hypothesis, conductive particles can move on the circuit board. Based on this assumption, we can distinguish between the top and underside of the circuit board when calculating the probability of short circuit. Mobile particles on the underside of the circuit board are subject to gravitational forces and thus detach themselves from the board and are unable to cause an electrical short circuit. It is impossible for particles on the PCB top side to become detached, they can only move sideways; consequently all particles can contribute to the probability of short circuit.

These two extreme cases of orientation at 0° (topside of circuit board) and 180° (underside of circuit board) lie at either end of the spectrum, but every angular position in between (depending on the mounting situation) can also be considered. The actual angular position can be entered in degrees in the calculation tool. The calculation tool then takes this into account when calculating the probability of failure.

About 2: Electrical contact inevitably occurs in addition to the purely geometric contact between metallic particles and current-carrying areas. Chapter 5.1 explains how the probability of contact is worked out.

About 3: Cleanliness analyses as per VDA 19 are carried out to determine the particle load. It is assumed that the experimentally determined particle load matches the actual number of mobile particles during operation. However, in reality particles in flux residues are fixed and thus not mobile, while punching burrs are removed only by the extraction process and not by vibration during opera-

tion, for example. Thus, there are discrepancies between the results of the cleanliness analysis and the number of particles that are actually mobile. An adjustment factor is used to disambiguate the two results. The adjustment factor was determined experimentally, see Chapter 5.2.

About 4: Other product-specific mitigation measures are conceivable which can be designed to reduce the probability of failure. For example:

- Areas of a heat transfer medium which retain and thus immobilise particles due to their adhesive characteristics
- Coated areas which mask the current-carrying areas, thus making them non-critical for metallic particles
- Gaps (e.g. between PCB and housing) which enable particles to detach from the PCB and gather in electrically non-critical areas of the assembly, without risk of migrating back to the PCB (see Chapter 5.3)
- Components with a permanent magnet which attracts and retains ferromagnetic particles

## 5.6 Example use of the risk assessment tool

### 5.6.1 Example use of the risk assessment tool for calculating failure rate

The theoretical basis for using the risk assessment tool explained in the previous chapter will now be illustrated using a concrete example.

The critical areas were determined for individual clearance classes on an example electronic assembly, and the particle load was additionally determined from cleanliness analyses. These data were then entered into the risk assessment tool along with additional data such as mounting position, probability of contact etc. The result for this particular example is a risk of electrical short circuit of 12 ppm.

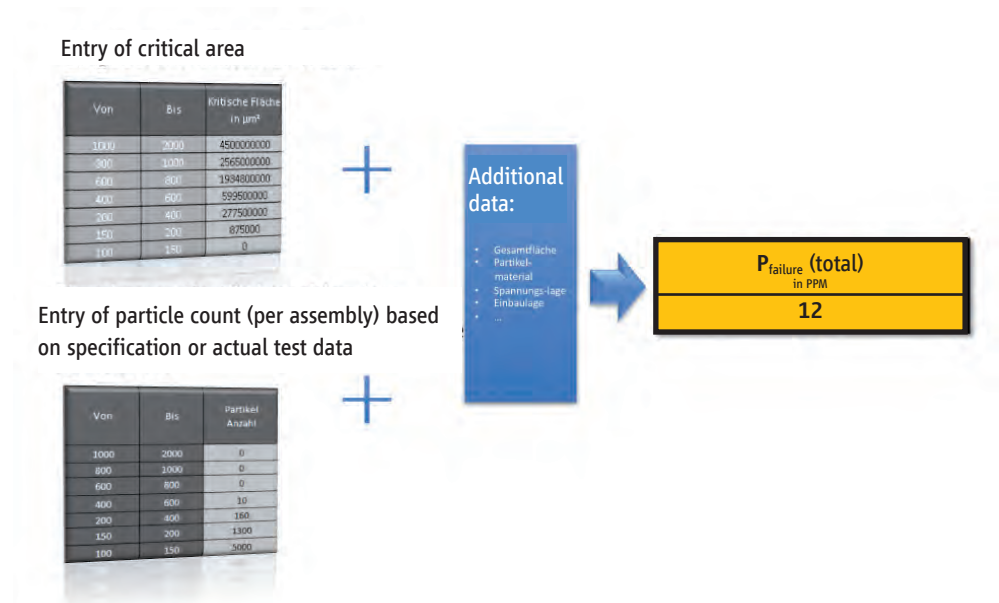
Because, as previously explained, assumptions in all cases were deliberately conservative, this result is also conservative compared with the actual failure rates in the field. In other words, the risk (calculated by the tool) is normally higher than the failure

rates observed from field data. Since the tool should ideally be used to perform a risk assessment in the design phase, it makes sense to adopt a conservative approach.

It is always advisable to compare the calculated risk with observed failure rates from field data, where available, to check the plausibility of the results.

As well as using the tool purely for a risk assessment, as illustrated in this example, the tool can also be used to assess design changes or to assess the risk of specification violations.

**Fig. 100: Example calculation 1: Calculating an absolute probability of failure**



### 5.6.2 Example use of the risk assessment tool for design changes

Layouts often change during the product development process (e.g. from B samples – procurement – to C samples – release) or with applications from existing platforms. The effect of these changes on the probability of short circuit can be assessed by performing a Delta analysis with the risk assessment tool. The example illustrated in 5.6.1 should be used as the “old” design. The following example serves as the “new” design; here the critical area has increased in one clearance class.

still be influenced by technology. The same approach can be taken for the critical areas, but here it is worth considering to what extent clearances in certain areas of the layout can be enlarged or protected to reduce the risk of electrical short circuit.

**Fig. 101: Example calculation 2: Calculating probabilities of failure for layout changes e.g. for a new generation component**

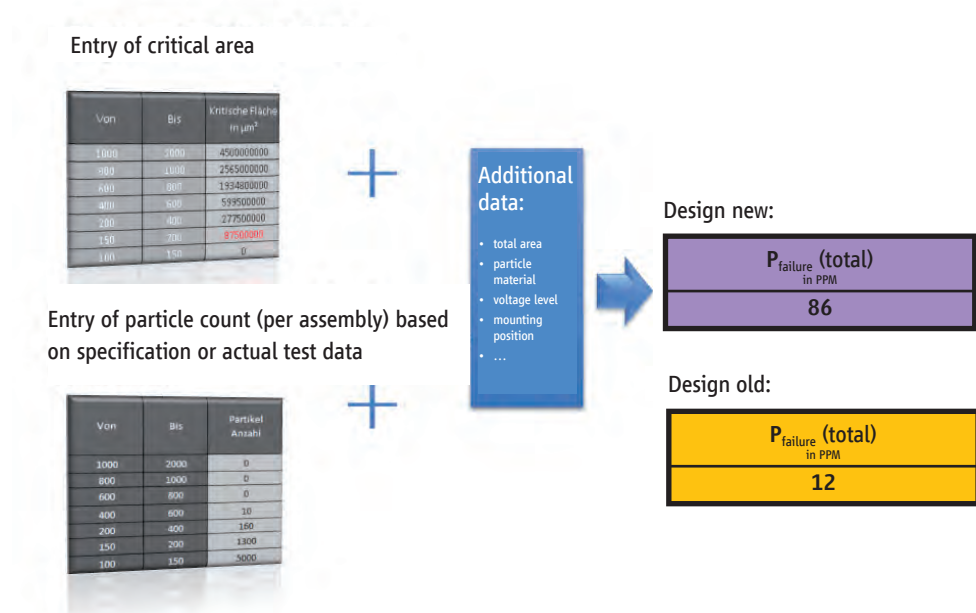


Figure 101 shows that this design change has significantly increased the risk of electrical short circuit.

Which are the most promising areas to make improvements that would reduce the risk potential with moderate effort and expense? To answer this we need to consider the main factors influencing risk in terms of both particle load and critical area. It makes sense to consider a potential reduction in particle load in the size classes which either constitute the majority of the overall risk or which can

Fig. 102: Example calculation 3: Optimising the main variables

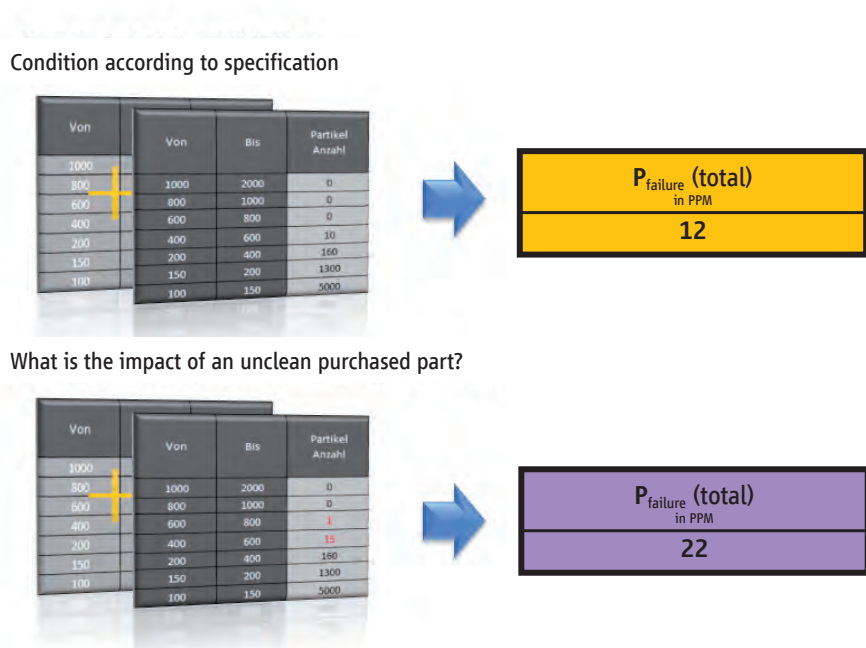


### 5.6.3 Example use of the risk assessment tool for specification violations

Since a probability of failure of 0 ppm is extremely rare, it makes sense to design the blueprint, manufacturing processes and components to a specific particle count. This is validated in the qualification test and stipu-

lated in the specifications. In the event of a deviation from the specified condition, the calculation tool can be used to determine the increased risk and thus allow appropriate action to be taken if necessary.

Fig. 103: Example calculation 3: Calculating the changed probability of failure in the event of specification violation



# 6 Summary

The key elements of the working group's appraisal can be summarised as follows:

- Detailed analysis of VDA 19
- Recommendations for implementing cleanliness analyses and presenting the results
- Description of the actual situation of particulate contamination during the manufacture of electric, electronic and electromechanical components, circuit boards and electronic assemblies. The extended and revised edition also includes sample results for purchased parts (e.g. chip components, ICs, aluminium die-cast housings, various connector types...).
- Risk assessment tool (<https://bauteilsauberkeit.zvei.org>) to calculate the risk of an electrical short circuit caused by metallic particles. To this end, experimental studies have also been conducted on the probability of electrical short circuits.
- Review of potential particle sources within processes
- Recommendations for cleanliness-controlled design and thus for the reduction of particles on the product
- Information on environmental cleanliness, transport and logistics
- Examination of other topics related to technical cleanliness such as film residue, ionic and biological contamination as well as whiskers
- Provision of sample clarification forms for analyses



# 7 Outlook

When the first edition of the ZVEI guideline on technical cleanliness was published in 2013, only part of the supply chain was confronted with the challenges of meeting technical cleanliness requirements. Now, almost exactly five years later, technical cleanliness has become a standard quality feature throughout the supply chain of the electronics industry.

Over the past five years, the ZVEI guideline has helped create a number of standards in the electronics industry. Extraction analysis is now established as the method of choice in this industry, results are generally presented based on a 1000 cm<sup>2</sup> reference surface area to enable comparability and finally, the supply chain has realised that statistical aspects must be included in discussions on technical cleanliness. Since it is now known that the results of technical cleanliness analyses can vary greatly, outlier rules must also be discussed and agreed between customer and supplier. It should also be noted that cleaning steps are not required along the entire supply chain in order to meet cleanliness requirements.

In addition to all the standards mentioned and the uniform procedures, which can be seen as a positive development, one central question continues to be handled inconsistently: the approach to determining specification values.

Specification values for metallic particles are often derived by determining the minimum clearance between potentials on an assembled PCB. In practice, the specification value is calculated on the basis of half this minimum potential clearance with a safety factor included.

It is the opinion of the ZVEI working group on component cleanliness that a function-based approach to defining reasonable specification values is difficult to implement and adhere to, but also unnecessary and therefore not very effective. Everyone would agree that with half a minimum potential clearance of e.g. 150 µm, the functional risk of an electrical short circuit in the presence of metallic particles of 149 µm will be more or less zero, but that this risk would not increase suddenly and discretely to 100 per cent in the presence of metallic particles of 151 µm. It is therefore evident that the risk increases steadily as a function of size and number of metallic particles.

The ZVEI working group has made considerable efforts in recent years to assess the functional risk of electrical short circuits caused by metallic particles. Experimental investigations have been carried out to determine the probability of contact. On this basis, a risk assessment tool (<https://bauteilsauberkeit.zvei.org>) has been developed for determining the probability of an electrical short circuit caused by metallic particles on an assembled circuit board.

This published tool makes it possible for the first time to estimate the risk of an electrical short circuit caused by metallic particles and express it in ppm. It is now possible to advance from a general specification value (half the minimum potential clearance) to an individual specification value that is determined by the functionality. It takes into account the individual layout of an assembled PCB, including the relevant potential clearances, as well as the individual metallic particle count determined for a product. The ZVEI guideline on component cleanliness thus creates the basis for determining and discussing specification values. It is hoped that this new approach will be intensively discussed along the supply chain, be widely accepted and become established as the procedure of choice for determining specification values.

This also eases the contradiction between the particle count accepted as the status quo for various electronic products in the supplier industry and the theoretical requirement for maximum values corresponding to half the potential clearance.

It can be assumed that the tool will enable more economical solutions for maintaining technical cleanliness to be found than has been the case to date.

It should also be noted that significantly more attention should be paid to cleanliness-controlled design and process selection.

In addition, the ZVEI working group on component cleanliness is currently drafting a "Technical Report" as part of its cooperation with the DKE committee K682 and the IEC committee TC91, WG1, thus paving the way for standards created in the German-speaking electronics industry to be observed and applied internationally.

The ZVEI working group on component cleanliness also intends to monitor the further development of technical cleanliness in the electronics industry even after publication of this completely revised and supplemented guideline and would like to continue to play an active role in addressing topics relating to technical cleanliness in the electronics industry in the future.

# 8 Related Topics

## 8.1 Ionic contamination

### Definition:

Ionic contamination refers to the accumulation of residues which can impair the function or service life of a printed circuit board or assembly e.g. due to corrosion, leakage currents or short circuits.

This residue is considered to be non-conductive in dry environments. A few monolayers of absorbed moisture building up on an assembly are sufficient to dissociate saline residues to form negatively charged ions (anions) and positively charged ions (cations), thereby making the residues conductive.

### Contamination sources:

There are many sources of ionic contamination, including the following production steps and auxiliary materials:

- Residues from production processes (e.g. solder paste and flux systems)
- Residues on purchased parts/material migration (e.g. PCB, electronic components)
- Faulty cleaning process (manual/automatic)
- Handling (e.g. fingerprints)
- Other

### Risks:

Most of the ions on the assembly come from the activators used in flux systems (e.g. halide compounds or weak organic acids). These residues can be water-soluble and hygroscopic, so that water vapour from ambient air accumulates on the circuit board even before the saturation limit has been reached. Leakage currents and electrochemical migration may occur if a water film forms on the assembly surface. If the leakage current is sufficiently high, the assembly function can be temporarily impaired as long as sufficient moisture is present. In addition, electrically conductive metallic dendrites appear after only a few minutes due to electrochemical migration. Once the dendritic growth bridges the gap between two potential differences, a short circuit occurs that can permanently damage the electronic assembly (see Fig. 104).

cuit occurs that can permanently damage the electronic assembly (see Fig. 104).

The formation of leakage currents and dendrites is accelerated by the presence of contaminants dissociated in the water film.

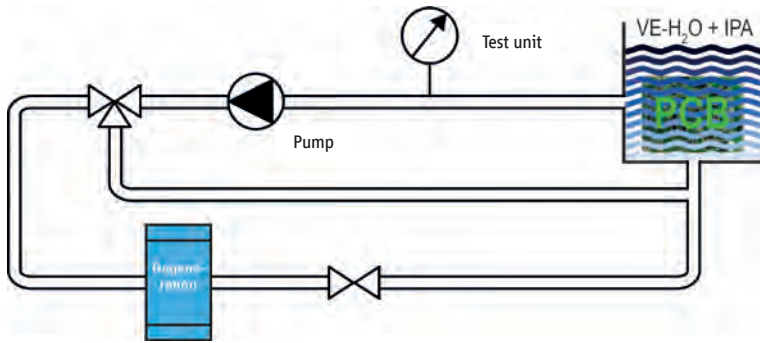
**Fig. 104: Dendritic growth between the gaps of a comb-patterned circuit board**



### Measurement of ionic contamination

IPC-TM-650 2.3.25 describes three testing methods: manual, static and dynamic extraction. In Europe, the most common method is static extraction. It involves placing an assembly in a closed test tank (Fig. 105). The assembly is fully immersed and bathed in a 2-propanol/DI water mixture (usually 75:25 vol.%, but also 50:50 vol.%). The test solution is agitated and its conductivity is measured. After a while, the ionic contaminants come off the assembly and dissolve in the test solution. This causes the electrical conductivity of the solution to rise continuously. The test is complete when only minor changes in conductivity are recorded, usually after 15 minutes.

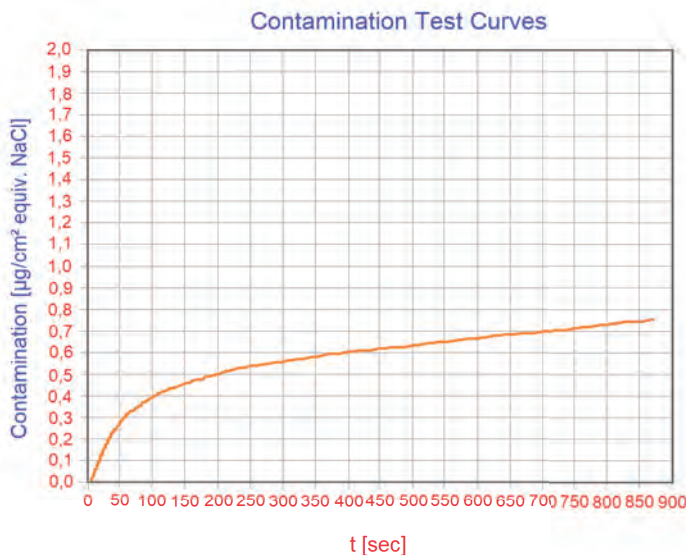
Fig. 105: Test procedure



Since the total amount of ionic components dissolved in the test solution is measured, irrespective of their electrical charge, an appropriate software is used to express the measured value as the equivalent sodium chloride content in micrograms per assembly surface area ( $\text{cm}^2$ ).

If, for example, a value of  $0.5 \mu\text{g}/\text{cm}^2$  NaCl equivalent is measured, this means that the total ionic contamination on the assembly behaves in the same way as the specified amount of sodium chloride in electrochemical terms. Fig. 106 maps a sample test curve.

Fig. 106: Test curve



### Interpretation of test data

The contamination determined [ $\mu\text{g}/\text{cm}^2$  equiv. NaCl] in the test procedure described above comprises the sum of all ions present. This means that ionic contaminants can only be assessed in their entirety. It is not possible to obtain information about either the type of substance or its critical impact. The type or composition of the contamination can be determined, for example, by ion chromatography. Neither is it possible to determine the spatial distribution of ions on the surface to be tested and the resulting potential risk from the test result. The blue test can be used to make the spatial distribution of the contaminants (weak organic acids) visible. A colour reaction reveals the activators (weak organic acids) of flux systems and shows their local distribution.

Several parameters influence the measured value "contamination [ $\mu\text{g}/\text{cm}^2$  equiv. NaCl]", such as:

- geometry of the assembly
- solder paste/flux system used (solubility)
- type of test method (dynamic/static)
- equipment used, test temperature and test time

This means that it is not possible to compare different assembly types or different test methods. It also shows that a generally accepted limiting value for all assemblies is no guarantee for a fail-safe assembly. If an assembly is classified as fail-safe after manufacture and subsequent qualification, the ionic contamination can be determined and this value can be used to monitor the manufacture of further assemblies of the same type. In addition, a possible failure of an assembly depends on product-specific parameters such as potential, potential clearances and application environment. The reliability of an assembly should be confirmed by other test methods, such as a climate test. The determination of ionic contamination is thus more of a tool to control the production process of an assembly.

### 8.1.1 Filmic contamination

Filmic contamination refers to the undesirable formation of a film on surfaces. Filmic contamination can be caused by chemical or biological films.

### 8.1.2 Biological films

Biological films consist of bacteria and/or fungi. They can be detected by means of nutrient solution tests.

### 8.1.3 Chemical films

Chemical films can consist of water containing dissociated salts or organic substances such as oils, fats or resins that can also encase ion components. These films are usually formed by the auxiliary materials used in production and associated processes.

## 8.2 Whiskers

As a result of EU waste directives such as the End-of-Life Vehicles Directive 2000/53/EC, which governs the use of hazardous substance, recovery systems and recycling in the automotive industry, the use of lead in electronics was restricted to a maximum concentration value of 0.1% by weight in homogeneous material some years ago.

These new EU directives and associated technical and price considerations prompted the industry to switch largely to pure tin or SnAgCu alloys (approx. 96% tin) for the metallisation of component connections.

Technical investigations on „reliability“ revealed that the problem of whiskering was on the rise again. This known phenomenon had been for all intensive purposes mitigated for decades through the addition of lead in tin. Safety-oriented users in the aerospace and automotive industry soon classified it as extremely critical. As a result, pure tin is only used in aerospace under a few specific conditions.

### What are whiskers?

Tin whiskers are microscopic electrically conductive hair-like crystalline structures that can grow from tin and tin alloy films. A whisker is capable of creating a short circuit by bridging over to a neighboring contact. It should be noted that whiskers can typically conduct currents of up to 60mA. At higher loads they tend to burn off or in the worst case scenario, they may ignite an electric arc capable of transmitting hundreds of amps. A whisker-induced short circuit may not only result in electrical failure; however could also set the component on fire due to arcing.

Whiskers grow out of the tin surface due to internal stress gradients.

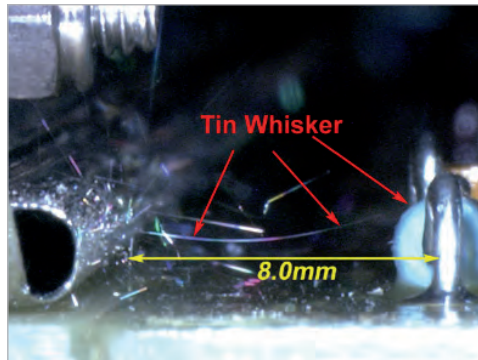
Some influencing factors on whisker growth include corrosion, surface oxides, irregular intermetallic growth, external forces - and the list goes on.

Therefore measures to eliminate whisker growth will be discussed only briefly here.

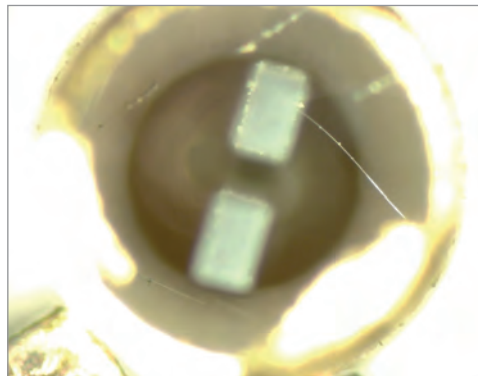
- Tin layers according to the ZVEI chart using appropriate barriers
- Post-heat treatment by „annealing“ or a reflow process to form a homogeneous intermetallic compound layer at least 0.5 µm thick
- Avoidance of external forces or any post-treatments that counteract the above-mentioned preventive measures

Unlike particles whose length can be clearly determined, whiskers continue to grow until the internal stresses subside.

**Fig. 107: Whisker growth of > 8 mm over a period of 10 years**



**Fig. 108: Whisker growth of > 2 mm over a period of 6 months**



It can be assumed that whiskers do not start to grow for several weeks or even months after deposition. Whisker lengths can range from a few micrometres to a few centimetres.

This makes it highly unlikely that whiskers will be found in a cleanliness analysis during production, which investigates particles  $\geq 50\mu\text{m}$ .

Details on whiskers, their growth and avoidance can be found in the ZVEI documentation „Pb-free: Sn Finishes with low Whisker Propensity, Processability, Soldering & Solder Heat Resistance for Automotive Applications“.

Furthermore, an international standard (IEC 60068-2-82) is available which specifies tests for qualification and verification of tin surfaces in regard to whisker growth.



## 9 Further Reading

- VDA 19 Part 1, Inspection of Technical Cleanliness – Particulate Contamination of Functionally-Relevant Automotive Components, 2nd edition, 2015
- VDA 19 Part 2, Technical Cleanliness in Assembly – Environment, Logistics, Personnel and Assembly Equipment, 1st edition 2010
- ISO 16232 (Part 1–10), Road vehicles – Cleanliness of components of fluid circuits, 2007
- Vinaricky, Elektrische Kontakte, Werkstoffe und Anwendungen, Springer Verlag, 2002
- Holm, Electric Contacts, Theory and Application, Springer Verlag, 1967
- Keil, Werkstoffe für elektrische Kontakte, Springer Verlag, 1960

# 10 Participating Companies

**Ba·Ti·Loy**

Gesellschaft für  
Lötmitteletechnik mbH



**BOSCH**

Technik fürs Leben

**brose**

Competence in Mechatronics

**cms**  
electronics

**Continental**

 **Fraunhofer**  
IPA



**KOSTAL**

  
**KSG** LEITERPLATTEN

**LOEWE.**

**MekTEC** Group



**muRata**  
INNOVATOR IN ELECTRONICS



**SEMIKRON**  
innovation + service

**Unimicron**  
GERMANY

**VAC**  
VACUUMSCHMELZE



**ZESTRON**  
High Precision Cleaning

**Zollner**



*The ZVEI working group on component cleanliness during their meeting (not all members present) at the Zestron premises in Ingolstadt on June 27, 2018.*

### Photo credits, sources and copyright

Table 1: Copyright © TDK Electronics AG

Table 2: Copyright © Zollner Elektronik AG

Table 3 and 4: Copyright © TDK Electronics AG

Table 5a, b, 6: Copyright © Kostal Kontakt Systeme GmbH and TE Connectivity Germany GmbH

Table 7: Copyright © Mektec Europe GmbH and Ruwel International GmbH

Table 8 to Table 28: Copyright © ZVEI Arbeitskreis Bauteilsauberkeit

Table 29: Copyright © Zollner

Fig. 1: Copyright © VDA e.V.

Fig. 2a, b: Copyright © Vacuumschmelze GmbH & Co. KG

Fig. 2c: Copyright © TE Connectivity Germany GmbH

Fig. 2d: Copyright © TDK Electronics AG

Fig. 3, 4, 5: Copyright © Vacuumschmelze GmbH & Co. KG

Fig. 6: Copyright © ZVEI Arbeitskreis Bauteilsauberkeit

Fig. 7, 8: Copyright © TE Connectivity Germany GmbH

Fig. 9 to 20: Copyright © Kostal Kontakt Systeme GmbH

Fig. 21: Copyright © Mektec Europe GmbH

Fig. 22: Copyright © Ruwel International GmbH; Bosch Motorsteuerung

Fig. 23 to 31: Copyright © Vacuumschmelze GmbH & Co. KG

Fig. 32 to 35: Copyright © TDK Electronics AG

Fig. 36 to 41: Copyright © Kostal Kontakt Systeme GmbH

Fig. 42: Copyright © TE Connectivity Germany GmbH

Fig. 43 to 51: Copyright © Kostal Kontakt Systeme GmbH

Fig. 52, 53: Copyright © TE Connectivity Germany GmbH

Fig. 54 to 56: Copyright © Hydac International GmbH

Fig. 57 to 62: Copyright © Ruwel International GmbH

Fig. 63 to 71: Copyright © Mektec Europe GmbH

Fig. 72: Copyright © VDA e.V.

Fig. 73 to 74: Copyright © Robert Bosch GmbH

Fig. 75 to 82: Copyright © Kostal Kontakt Systeme GmbH

Fig. 83 to 85: Copyright © Vacuumschmelze GmbH & Co. KG

Fig. 86: Copyright © Zollner Elektronik AG

Fig. 87: Copyright © ZVEI Arbeitskreis Bauteilsauberkeit

Fig. 88, 89: Copyright © Vacuumschmelze GmbH & Co. KG

Fig. 90, 91: TE Connectivity Germany GmbH

Fig. 92: Copyright © Zollner Elektronik AG

Fig. 93: TE Connectivity Germany GmbH

Fig. 94 to 96: Copyright © ZVEI Arbeitskreis Bauteilsauberkeit

Fig. 97 to 99: Copyright © Continental AG

Fig. 100 to 103: Copyright © ZVEI Arbeitskreis Bauteilsauberkeit

Fig. 104: Copyright © Balver Zinn Josef Jost GmbH & Co. KG

Fig. 105, 106: Copyright © Kolb Cleaning Technology GmbH

Fig. 107: Copyright © NASA

"Tin Whiskers: A History of Documented Electrical System Failures", April 2006  
[https://nripp.nasa.gov/whisker/reference/tech\\_papers/2006-Leidecker-Tin-Whisker-Failures.pdf](https://nripp.nasa.gov/whisker/reference/tech_papers/2006-Leidecker-Tin-Whisker-Failures.pdf)

Fig. 108: DfR Solutions

Fig. 109, 110: Copyright © Zollner Elektronik AG

Fig. 111, 112: Copyright © ZVEI Arbeitskreis Bauteilsauberkeit

Photo working group (above): Copyright © ZVEI Arbeitskreis Bauteilsauberkeit

# 11 Appendix

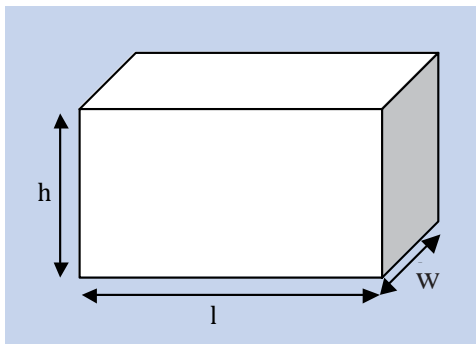
## Determining the surface area of components and assembled circuit boards

Determining the component surface area is difficult and time-consuming due to the complex surface structure of assembled circuit boards.

The working committee has therefore specified a standard method to determine the surface area, which provides largely accurate and comparable results while minimizing time and effort.

## Equations for cuboid components:

**Fig. 109: Dimensions of cuboid components**



Chip components, BGA, SO, SOT QFP, tantalum capacitors, etc.:

$$O_Q = 2 \cdot h \cdot (l + w) + l \cdot w$$

Circuit board:

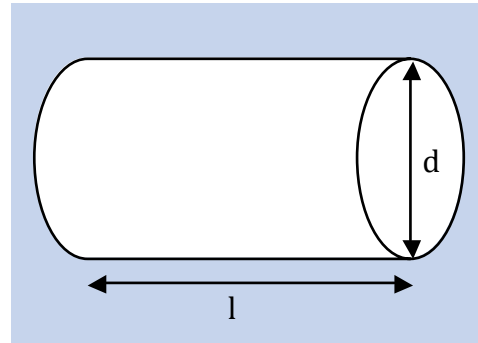
$$O_L = 2 \cdot (l \cdot h + w \cdot h + l \cdot w)$$

Connector:

$$O_S = [2 \cdot h \cdot (l + w) + l \cdot w] \cdot 2$$

## Equations for cylindrical components:

**Fig. 110: Dimensions of cylindrical components**



Horizontal mounting  
(e.g. MELF components):

$$O_{Zl} = \pi \cdot d \cdot (l + \frac{d}{2})$$

Vertical mounting  
(e.g. electrolytic capacitor or e-cap):

$$O_{Zs} = \pi \cdot d \cdot (l + \frac{d}{4})$$

## Total surface area:

$$O_{total} = O_L + \sum_{i=1}^m O_{Qi} + \sum_{j=1}^n O_{Zlj} + \sum_{k=1}^o O_{Zsk} + \sum_{l=1}^p O_{Sl}$$

- The base area of flat components (e.g. chip components) is not included in the calculation.
- The equation for determining the surface area of PCBs applies only to components that are virtually rectangular. Drill holes are not considered. Other shapes must be calculated individually according to the specific circuit board.
- The surface area of connectors is generally assumed to be twice the surface area of a cuboid (without base area) on account of their irregular structure and inner surfaces.

Table 29 provides sample values of standard components to determine the component surface area.


**Table 29: Sample values of standard components to determine the component surface area**

Function	Package type	Length [mm]	Width [mm]	Height [mm]	Package shape	Surface area [mm <sup>2</sup> ]
Resistor	0201	0.60	0.30	0.23	Rectangular	0.59
Resistor	0402	1.00	0.50	0.32	Rectangular	1.46
Resistor	0603	1.55	0.85	0.45	Rectangular	3.48
Resistor	0805	2.00	1.25	0.52	Rectangular	5.88
Resistor	1206	3.20	1.60	0.55	Rectangular	10.40
Resistor	1210	3.20	2.50	0.55	Rectangular	14.27
Resistor	1812	4.50	3.20	0.60	Rectangular	23.64
MLCC	0402	1.00	0.50	0.50	Rectangular	2.00
MLCC	0603	1.60	0.80	0.80	Rectangular	5.12
MLCC	0805	2.00	1.25	0.85	Rectangular	8.03
MLCC	1206	3.20	1.60	1.15	Rectangular	16.16
MLCC	1210	3.20	2.50	2.00	Rectangular	30.80
MLCC	1808	4.50	2.00	1.02	Rectangular	22.26
Shunt	2010	5.08	2.54	0.64	Rectangular	22.58
Shunt	2512	6.35	3.05	0.70	Rectangular	32.53
Shunt	2725	6.90	6.60	2.40	Rectangular	110.34
Shunt	2816	7.10	4.20	0.80	Rectangular	47.90
Shunt	3920	10.00	5.20	0.50	Rectangular	67.20
Tantal	A	3.20	1.60	1.60	Rectangular	20.48
Tantal	B	3.50	2.80	1.90	Rectangular	33.74
Tantal	C	6.00	3.20	2.60	Rectangular	67.04
Tantal	D	7.30	4.30	2.80	Rectangular	96.35
Quartz	3225	3.20	2.50	0.90	Rectangular	18.26
Quartz	5032	5.00	3.20	1.00	Rectangular	32.40
Inductor(Chip)	0402	0.95	0.45	0.45	Rectangular	1.69
Inductor(Chip)	0603	1.45	0.80	0.80	Rectangular	4.76
Inductor(Chip)	0805	2.00	1.25	0.85	Rectangular	8.03
Varistor	0603	1.60	0.80	0.90	Rectangular	5.60
Varistor	0805	2.01	1.25	1.02	Rectangular	9.16

Function	Package type	Diameter [mm]	Height [mm]	Package shape	Surface area [mm <sup>2</sup> ]
Melf-Resistor	0102	1.10	2.20	Cylindrical	9.50
Melf-Resistor	0204	1.40	3.60	Cylindrical	18.91
Melf-Resistor	0207	2.20	5.80	Cylindrical	47.69
Capacitor	SMD Al-Cap	6.90	18.50	Cylindrical	438.42
Capacitor	SMD Al-Cap	8.50	18.50	Cylindrical	550.76
Capacitor	axial Al-Cap	8.00	8.50	Cylindrical	263.89
Capacitor	axial Al-Cap	10.50	18.50	Cylindrical	696.84
Capacitor	axial Al-Cap	10.50	25.00	Cylindrical	911.26
Capacitor	axial Al-Cap	10.50	30.50	Cylindrical	1092.69
Capacitor	axial Al-Cap	13.00	30.50	Cylindrical	1378.37
Capacitor	axial Al-Cap	15.50	30.50	Cylindrical	1673.88
Capacitor	axial Al-Cap	16.50	39.90	Cylindrical	2282.09
Capacitor	axial Al-Cap	18.00	20.00	Cylindrical	1385.44
Capacitor	axial Al-Cap	18.50	30.50	Cylindrical	2041.45
Capacitor	axial Al-Cap	18.50	41.50	Cylindrical	2680.76
Capacitor	axial Al-Cap	21.50	41.50	Cylindrical	3166.14

**Fig. 111.1: Ambient cleanliness clarification form**

Index: 01.2017

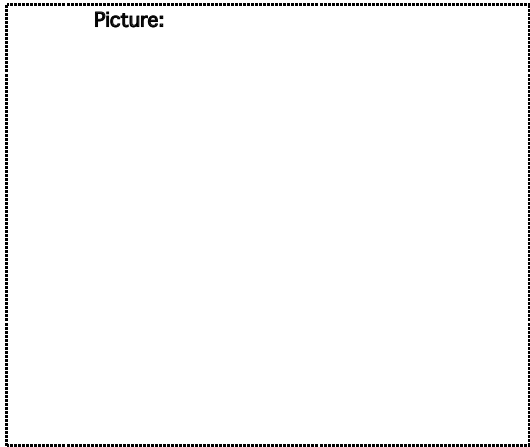


### Clarification sheet for ambient cleanliness

**Filled in by the requester**

Client	Analysis laboratory
Company: <input type="text" value="Musterfirma GmbH"/>	Company: <input type="text" value="Musterfirma GmbH"/>
Street/No.: <input type="text" value="Musterstr. 2"/>	Street/No.: <input type="text" value="Musterstr. 2"/>
Postcode City: <input type="text" value="12345"/> <input type="text" value="Musterstadt"/>	Postcode City: <input type="text" value="12345"/> <input type="text" value="Musterstadt"/>
Contact person: <input type="text" value="Max Mustermann"/>	Contact person: <input type="text" value="Max Mustermann"/>
Phone or mobile: <input type="text" value="01234 56789"/>	Phone or mobile: <input type="text" value="01234 56789"/>
E-Mail: <input type="text" value="max.mustermann@e_mail.de"/>	E-Mail: <input type="text" value="max.mustermann@e_mail.de"/>

**Particle trap information:**

No. particle trap: <input type="text" value="10"/> from <input type="text" value="20"/>	<p style="text-align: center;">Picture:</p> 
Installation site: <input type="text" value="Machine 4711"/>	
Installation altitude [in m]: <input type="text" value="1,0"/>	
Area of the trap [in cm <sup>2</sup> ]: <input type="text" value="15,2"/> <i>When a particle stamp is used (area x amount of stampings)</i>	
Executive employee: <input type="text" value="Max Mustermann"/>	
Installation period: <input type="text"/>	
Activation date: <input type="text" value="DD.MM.YYYY"/> <input type="text" value="HH:MM"/>	
Deactivation date: <input type="text" value="DD.MM.YYYY"/> <input type="text" value="HH:MM"/>	
Duration [in h]: <input type="text" value="167,25"/>	

**Filled in by qualified staff**

**Information on the analysis**

Microscopy   
  Microscopy with polarization filter   
  REM / EDX   
  \_\_\_\_\_

Details:

Analysis:  Particle size class from  to

Algorithm for determining sizes:

Particle:   Feret max.  \_\_\_\_\_

Threads:   Feret max.  Stretched length  Relation 10/1



**Fig. 111.2: Ambient cleanliness clarification form**

Index: 01.2017




Particle count			
<input checked="" type="checkbox"/> Metallic particles	<input checked="" type="checkbox"/> Threads	<input type="checkbox"/> Corrundum/Sand	<input type="checkbox"/> _____
<input checked="" type="checkbox"/> Non-metallic particles			
Particle count:		<input checked="" type="checkbox"/> Length	<input type="checkbox"/> Width <input type="checkbox"/> _____
Particle quantity		Illig value	
<input checked="" type="checkbox"/> CCC	<input checked="" type="checkbox"/> Per trap	<input checked="" type="checkbox"/> Per 1.000 cm <sup>2</sup>	<input checked="" type="checkbox"/> Metallic particles
			<input checked="" type="checkbox"/> Non-metallic particles
			<input checked="" type="checkbox"/> Threads
			<input checked="" type="checkbox"/> Total with threads <input checked="" type="checkbox"/> Total without threads
Post-treatment of the particle traps			
<input checked="" type="checkbox"/> Sent back particle traps	<input type="checkbox"/> Dispose particle traps		
Presentation of the results			
Size and amount of particles with pictures:		<input checked="" type="checkbox"/> Total filter as picture	
<input checked="" type="checkbox"/> Metallic particles	4		
<input checked="" type="checkbox"/> Non metallic particles	4		
<input checked="" type="checkbox"/> Threads	3		
Amount of particles with pictures:		<input checked="" type="checkbox"/> Length	<input checked="" type="checkbox"/> Width <input type="checkbox"/> _____
The largest particles sorted by:		<input checked="" type="checkbox"/> Length	<input type="checkbox"/> Width <input type="checkbox"/> _____
Report			
Language of the reports:		Dispatch via:	File format:
<input checked="" type="checkbox"/> German	<input checked="" type="checkbox"/> English	<input checked="" type="checkbox"/> E-Mail	<input checked="" type="checkbox"/> YYYY-MM-DD_Analysis-No.
<input type="checkbox"/> _____		<input type="checkbox"/> Others	<input type="checkbox"/> _____
Estimated dispatch of the samples: DD.MM.YYYY		Desired date: KW KW_YYYY	
_____ Max Mustermann		_____ DD.MM.YYYY	
Client: (Name, date)			

**Fig. 112.1: Component cleanliness clarification form**

Index: 01.2017



**Clarification sheet for component cleanliness**

Filled in by the requester	
Client	Analysis laboratory
Company: <input type="text" value="Musterfirma GmbH"/>	Company: <input type="text" value="Musterfirma GmbH"/>
Street/No.: <input type="text" value="Musterstr. 2"/>	Street/No.: <input type="text" value="Musterstr. 2"/>
Postcode City: <input type="text" value="12345"/> <input type="text" value="Musterstadt"/>	Postcode City: <input type="text" value="12345"/> <input type="text" value="Musterstadt"/>
Contact person: <input type="text" value="Max Mustermann"/>	Contact person: <input type="text" value="Max Mustermann"/>
Phone or mobile: <input type="text" value="01234 56789"/>	Phone or mobile: <input type="text" value="01234 56789"/>
E-Mail: <input type="text" value="max.mustermann@e_mail.de"/>	E-Mail: <input type="text" value="max.mustermann@e_mail.de"/>
Test sample information:	
Designation: <input type="text" value="Artikel 123456"/>	<div style="border: 1px dashed black; padding: 5px;"> <p style="text-align: center;">Picture / drawing of the test sample:</p>  </div>
Project number/name: <input type="text" value="Projekt:11111"/>	
Part number: <input type="text" value="123456789"/>	
Remark: <input type="text"/>	
Customer: <input type="text" value="Musterfirma GmbH"/>	
Area to analyze:	Lot size per analysis: <input type="text" value="26"/> Number of analyses: <input type="text" value="3"/> Total surface area cm <sup>2</sup> <input type="text" value="1015"/> <i>[1000 cm<sup>2</sup> aspired]</i>
<input checked="" type="checkbox"/> <input type="text" value="Entire part"/>	
<input type="checkbox"/> <input type="text" value="Defined area"/>	
<input checked="" type="checkbox"/> <input type="text" value="Surface per part [cm&lt;sup&gt;2&lt;/sup&gt;]: 39,04"/>	
Extraction conditions (for documentation by the client)	
Who: <input type="text" value="Max Mustermann"/>	Where: <input type="text" value="Shipping"/>
When: <input type="text" value="TT.MM.JJJJ"/>	How: <input type="text" value="Manual removal with gloves from series packaging"/>
Requirements	
Test specification: <input type="text" value="Musterfirma GmbH 1234"/>	With random outlier rule: <input type="checkbox"/> Yes <input checked="" type="checkbox"/> No
Details: <input account."="" and="" any="" are="" blasting="" corundum,="" glass="" into="" kind="" ma="" not="" of="" quartz,="" sand,="" taken="" type="text" value="\"/>	Details: <input type="text"/>
Requirement specification: <input type="text" value="Musterfirma GmbH 5678"/>	With escalation strategy: <input type="checkbox"/> Yes <input checked="" type="checkbox"/> No
Details: <input type="text" value="Target value 800 μm"/>	Details: <input type="text"/>
Is a declining test required?:	
<input type="checkbox"/> Yes <input checked="" type="checkbox"/> No <input type="checkbox"/> <input type="text" value="Default see test specification"/>	<input type="checkbox"/> <input type="text" value="Already"/>
<input type="checkbox"/> <input type="text" value="Component family, verification of parameters by double inspection (with reference to test)"/>	

**Fig. 112.2: Component cleanliness clarification form**

Index: 01.2017



**Filled in by qualified staff /after consultation with the laboratory**

Information on the analysis	
<input type="checkbox"/> Microscopy <input checked="" type="checkbox"/> Microscopy with polarization filter <input type="checkbox"/> REM / EDX <input type="checkbox"/> _____	
Details: _____	
With gravimetry <input checked="" type="checkbox"/> Yes <input type="checkbox"/> No	
Analysis: Particle size class from E [50µm] to N [> 3000µm]	
Details: _____	
Algorithm for determining sizes:	
Particles: <input checked="" type="checkbox"/> Feret max. <input type="checkbox"/> _____	
Threads: <input type="checkbox"/> Feret max. <input checked="" type="checkbox"/> Stretched length <input type="checkbox"/> Relation 10/1	
Particle count	
<input checked="" type="checkbox"/> Metallic particles <input checked="" type="checkbox"/> Threads <input type="checkbox"/> Corundum/Sand <input type="checkbox"/> _____	
<input checked="" type="checkbox"/> Non-metallic particles	
Particle quantity	Surface cleanliness value (OSW)
<input checked="" type="checkbox"/> CCC <input checked="" type="checkbox"/> Per test batch <input checked="" type="checkbox"/> Per 1000 cm <sup>2</sup> <input checked="" type="checkbox"/> Per component	<input checked="" type="checkbox"/> Metallic particles <input checked="" type="checkbox"/> Non-metallic particles <input checked="" type="checkbox"/> Threads <input checked="" type="checkbox"/> Total with threads <input checked="" type="checkbox"/> Total without threads
Filter selection	
Filtration mode: <input type="checkbox"/> Cascade filtration <input checked="" type="checkbox"/> Single filtration <input type="checkbox"/> _____	
Filtration type: <input type="checkbox"/> PET mesh filter _____ [e.g. 5 µm] <input checked="" type="checkbox"/> Pore filter 5 µm <input type="checkbox"/> Cellulose filter _____ <input type="checkbox"/> _____	
Post-treatment of the samples & filters	
<input checked="" type="checkbox"/> Sent back samples <input type="checkbox"/> Dispose samples	
<input checked="" type="checkbox"/> Sent back filters <input checked="" type="checkbox"/> In slide frame <input type="checkbox"/> Laminated <input type="checkbox"/> Electronic & archiving in the laboratory	
<input type="checkbox"/> Dispose filters	

**Fig. 113.3: Component cleanliness clarification form**

Index: 01.2017



Presentation of the results			
Size and amount of particles with pictures:	<input checked="" type="checkbox"/>	Total filter as picture	
<input checked="" type="checkbox"/> Metallic particles		4	
<input checked="" type="checkbox"/> Non metallic particles		4	
<input checked="" type="checkbox"/> Threads		3	
Amount of particles with pictures:	<input checked="" type="checkbox"/> Length	<input checked="" type="checkbox"/> Width	<input type="checkbox"/> _____
The largest particles sorted by:	<input checked="" type="checkbox"/> Length	<input type="checkbox"/> Width	<input type="checkbox"/> _____
Packing			
<input type="checkbox"/> Original packing	<input type="checkbox"/> Antistatic PE bag	<input checked="" type="checkbox"/> Packing is part of the tests	
<input type="checkbox"/> _____			
Pre-treatment in the laboratory			
<input type="checkbox"/> Insulation	<input type="checkbox"/> Disassembly	<input type="checkbox"/> Demagnetising	<input type="checkbox"/> Prior cleaning <input type="checkbox"/> _____
Report			
Video of the components:	<input checked="" type="checkbox"/> No	<input type="checkbox"/> Per declining test	<input type="checkbox"/> Per analysis
Language of the reports:	Dispatch via:		File format:
<input checked="" type="checkbox"/> German	<input checked="" type="checkbox"/> English	<input checked="" type="checkbox"/> E-Mail	<input checked="" type="checkbox"/> YYYY-MM-DD_Analysis-No.
<input type="checkbox"/> _____	<input type="checkbox"/> Others	<input type="checkbox"/> _____	
Estimated dispatch of the samples:	DD.MM.YYYY	Desired date: KW	KW_YYYY
_____ Max Mustermann		_____ TT.MM.JJJJ	
Client: (Name, date)			











ZVEI - Zentralverband Elektrotechnikund  
Elektronikindustrie e. V.  
German Electrical and Electronic  
Manufacturers' Association  
Lyoner Strasse 9  
60528 Frankfurt am Main, Germany  
Phone: +49 69 6302-0  
Fax: +49 69 6302-317  
E-mail: [zvei@zvei.org](mailto:zvei@zvei.org)  
[www.zvei.org](http://www.zvei.org)

